

SurePress L-4533 Digital Label Press

Versatile printing.
Consistent quality.



EPSON
EXCEED YOUR VISION

Expand your offering and boost your bottom line

The SurePress L-4533 inkjet digital label press makes high quality short-run printing easier and more efficient. It allows users to expand their service offerings and improve profitability.

The press delivers exceptional print quality, across a wide range of label substrates offering consistent colour reproduction and precise colour matching. The press is easy to operate, enabling you to focus on managing your business, and not the press.



Liquors

Labels for wine bottles, craft beer and spirits



Industrial Products

Labels for electronic products, name plates for products of limited quantity



Novelty

Labels for personalised or limited quantity products



Food/Beverages

Labels for jams, cheeses, hams and bottled water



Pharmaceutical

Labels for supplements, medicines



Masking Tape

Masking tape, craft tape



Household Products

Labels for private brand samples and local brand products



Cosmetics

Labels for private brand cosmetics and samples

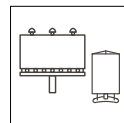

Window Graphics/POP

Indoor/outdoor POP, posters, signage

Exceptional quality in label printing

Selected print modes have been enhanced to improve image quality. The new edge smoothing function delivers even sharper text and crisp lines at a faster print speed.



Character edges are straight and sharp.



Colours are richer and more natural.



ALKHAM NURSERY

Orchid care information

Position: Place in good natural light but away from direct sunlight.

Temperature: Ideally keep in a warm room with a temperature between 17 - 23°C (63 - 73°F).

Watering: Water weekly by drenching the moss or bark then allow to drain. Do not allow the roots to become waterlogged.

Feeding: Using a houseplant food occasionally will prolong plant life. Use only whilst the orchid is in flower.

Flowering plants: After flowering, cut the stem down to the first stem joint, reduce the temperature to approx 10°C (50°F) for 4 weeks and a new flower spike may follow.

! Natural toxins in some plants make them harmful if eaten by humans or animals. Wash your hands after handling as some plants may cause skin or eye irritation. Protect surface as scratching or staining may occur.

Twin Stem Phalaenopsis Orchid (Moth Orchid)

Colour(s);	Yellow
Number of stems;	Typically 2
Height;	57cm



Display Until:

22 Sept

Price:

£12.00

Printed by Epson
SurePress L-4033

www.epson.eu/surepress

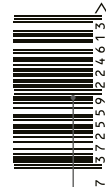

Produced for Alkham Nursery Group, Bracknell, Berkshire, RG11 5DF, UK

www.alkhamnursery.com



Reversed text is clearly legible.



Barcodes are crisp and sharp.

High quality, accurate colour printing

Managing print quality consistently across a wide range of substrates is a challenge.

Epson produces and controls all technology inside the SurePress L-4533, from printheads to ink and software, and this is how we can achieve precise colour quality for every job on each substrate, every time.

Epson micro piezo multi-printhead array

Epson's printheads feature micro-fine nozzles that deliver perfectly accurate dot shapes and placement for each colour. This results in superior colour quality and sharp detail for barcodes and small text.



Epson Micro Piezo multi-printhead array

Epson SurePress AQ Ink

A water-based pigment ink-set has been developed specifically for the SurePress L-4533 with six colours including green and orange for an extra-wide colour gamut. This ensures accurate colour reproduction for precise colour matching with excellent adhesion on a wide variety of label substrates, without the need for any pre-treatments or coatings. An opaque white ink is available on the AW model.

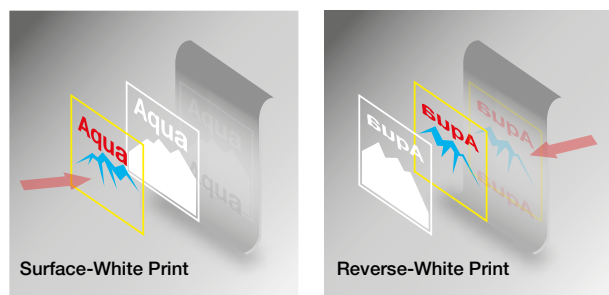

The SurePress L-4533 provides the flexibility of printing white first or white last

Variable-Sized Droplet Technology

Epson's Variable-Sized Droplet Technology produces different size ink droplets as small as 3.0 picoliters. These precisely sized droplets allow the ink to be uniformly applied, contributing to smooth gradations and accurate colours for optimum image quality.

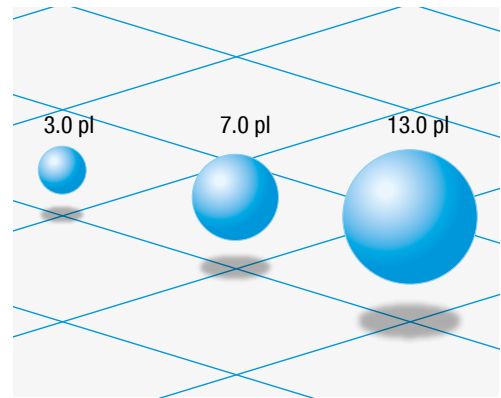

Variable Sized Droplet Technology

Expanded colour gamut

Epson inks are known for their wide colour gamut and accurate colour reproduction. With Green and Orange inks in addition to Cyan, Magenta, Yellow and Black, the inks expand the colour gamut for even higher accuracy and colour saturation. The difference is especially noticeable in the bright green to yellow and yellow-orange-red portions of the colour space. You will be able to match colours more accurately and the highly-saturated colours make labels look even more appealing.

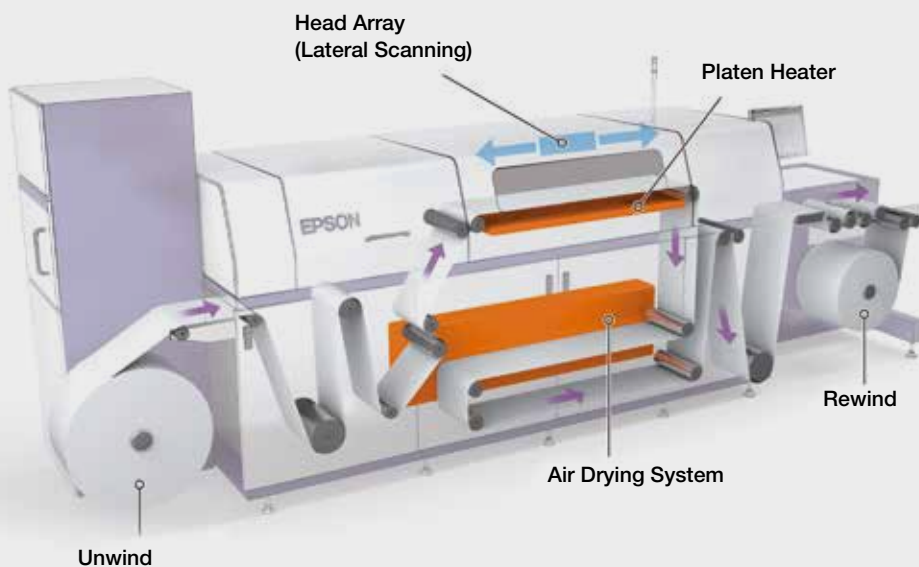
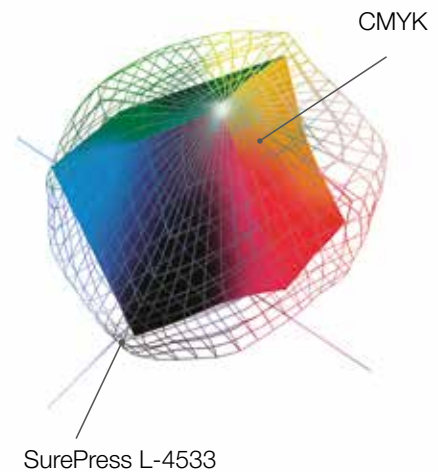

Dual drying system

A unique two-stage drying process ensures optimum ink adhesion to label substrates.

The first drying stage is a platen heater, which starts fixing the image onto the substrate.

The substrate then moves down to the second drying stage, where hot air blown from a fan evaporates the remaining moisture.

After drying, the substrate moves directly to the rewinder.

Streamline your production



The SurePress L-4533 offers effortless job printing with minimal maintenance.

Offering improved image quality at high print speeds, the press is reliable, consistent and easy to use. A single operator can run multiple presses safely and easily, enabling you to increase productivity.

The press features auto head maintenance which delivers a faster, more efficient and reliable workflow, allowing you to handle a higher number of short-run jobs, resulting in significantly improved profitability.

User-friendly interface, touch-screen operation

The touch-screen panel is extremely simple to use, with an intuitive interface that keeps you in control of every aspect of printing. Job configurations can be quickly set and operating status can be readily checked at any time. Settings for specific types of jobs can be saved, so set-up is even faster the next time for repeat jobs.

Ease of use

Save time and money with minimal maintenance requirements. The printing mechanism is easy to access and maintain, and ink replacement is quick and easy with no need to stop the press — simply replace the empty ink cartridges and continue printing. Remote diagnostics and analysis is available to support your business.



Fast and efficient digital workflow

Conventional workflows involve additional time-consuming steps that are not necessary with the SurePress L-4533. A fast and efficient digital workflow reduces time and improves turnaround for printing jobs.

Improved turn-around

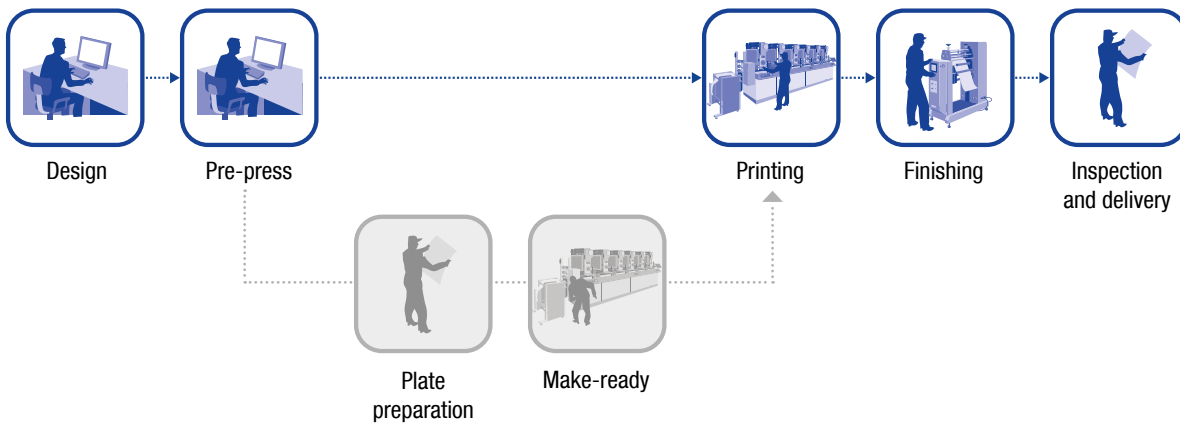

Conventional workflows require additional plate preparation and make-ready steps.

Eco features



Pre-treatment of substrates is not necessary.



SurePress AQ ink is water-based and has good adhesion on a wide variety of standard label substrates.



Resource-saving, no use of chemicals, plates or films.



Simple colour matching process reduces substrate wastage and ink consumption.



Both the SurePress L-4533 and SurePress AQ Ink are in compliance with EU Directive RoHS (Restriction of Hazardous Substances).

Specifications

SurePress L-4533A/AW	
Print technology	Epson Micro Piezo™ inkjet technology
Resolution	Up to 720 x 1440 dpi
Ink type	SurePress AQ Inks ¹
Ink cartridges	Black, Uncoated Black, Cyan, Magenta, Yellow, Orange, Green, Over print liquid, White (AW model)
Web width	80 mm to 333 mm adjustable to support any width in this range
Image size	315.2 mm x 914.4 mm
Print speed	Up to 8.2 metres per min
Substrate support	Standard self-adhesive label substrates, semi gloss, gloss and matte paper, BOPP, PET and Yupo
Substrate thickness	80 to 320 microns
Unwinder capacity (max)	100 kg weight/600 mm diameter with 76 mm inner core
Network connectivity	Ethernet 1000 Base-T or higher is recommended
Dimensions of Press (WxDxH)	3788 mm x 1847 mm x 2016 mm (excluding rewinder)
Dimensions of Rewinder (WxDxH)	1310 mm x 900 mm x 1000 mm
Power Requirements	Rated voltage ± 10% (180-220 V): Rated voltage AC (3 phases 3 lines) 200 V
Weight of Press	1730 kg including rewinder

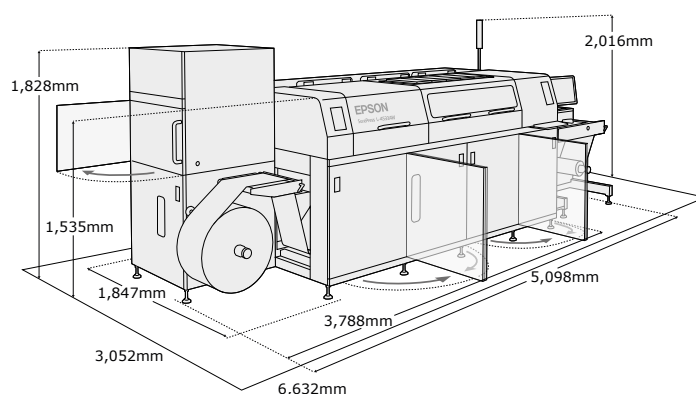

**Better Products
for a Better Future™**



Epson CoverPlus

Fast. Reliable. Professional

Epson Finance Solutions

Product specifications are subject to change without notice.

Trademarks and registered trademarks are the property of Seiko Epson Corporation or their respective owners.

¹Epson SurePress AQ ink is not intended for direct food contact printing

EPSON AUSTRALIA
3 Talavera Road
North Ryde NSW 2113
1300 361 054
www.epson.com.au

EPSON NEW ZEALAND
Level 2 7-9 Fanshawe
Auckland 1010 New Zealand
0800 237 766
www.epson.co.nz

ABN 91 002 625 783
09/17

EPSON