

EPSON
EXCEED YOUR VISION

User's Guide



Home Projector

EH-TW570





Notations Used in This Guide

- **Safety indications**

The documentation and the projector use graphical symbols to show how to use the projector safely. Please understand and respect these caution symbols in order to avoid injury to persons or property.

 Warning	This symbol indicates information that, if ignored, could possibly result in personal injury or even death due to incorrect handling.
 Caution	This symbol indicates information that, if ignored, could possibly result in personal injury or physical damage due to incorrect handling.

- **General information indications**

Attention	Indicates procedures which may result in damage or injury if sufficient care is not taken.
	Indicates additional information and points which may be useful to know regarding a topic.
	Indicates a page where detailed information regarding a topic can be found.
	Indicates that an explanation of the underlined word or words in front of this symbol appears in the glossary of terms. See the "Glossary" section of the "Appendix".  "Glossary" p.145
[Name]	Indicates the name of the buttons on the remote control or the control panel. Example: [Esc] button
Menu Name	Indicates Configuration menu items. Example: Select Brightness from Image . Image - Brightness

Notations Used in This Guide 2

Introduction

Projector Features 8

Project Realistic 3D Images	8
Quick and Easy Set up, Projection, and Storage	8
Connecting with a USB cable and projecting (USB Display)	8
Detecting projector movements and automatically correcting image distortion	8
Horizontal keystone adjuster	8
Useful Functions for Projecting Images	9
Project two images simultaneously (Split Screen)	9
Increasing projection content in wide (WXGA) screen	9
Connect a USB storage device and project movies or images (PC Free)	9
Various functions for excellent power saving	9
Making the most of the remote control	9
Enlarge and project your files with the Document Camera	9
Enhanced security functions	10
Connecting to a wireless LAN and projecting images	10

Part Names and Functions 11

Front/Top	11
Rear	12
Base	13
Control Panel	14
Remote Control	15
Replacing the remote control batteries	18
Remote control operating range	19

Preparing the Projector

Installing the Projector 21

Installation Methods	21
Installation methods	21

Screen Size and Approximate Projection Distance	22
---	----

Connecting Equipment 23

Connecting Image Sources	23
Connecting a Computer	25
Connecting a Smartphone or Tablet Device	26
Connecting USB Devices	27
Connecting External Equipment	28
Installing the Wireless LAN Unit	30
Installing the Quick Wireless Connection USB Key	30

Basic Usage

Projecting Images 32

From Installation to Projection	32
Automatically Detect Input Signals and Change the Projected Image (Source Search)	33
Switching to the Target Image by Remote Control	34
Projecting with USB Display	34
System requirements	34
Connecting for the first time	35
Uninstalling	36

Adjusting Projected Images 38

Correcting Keystone Distortion	38
Correcting automatically	38
Correcting manually	39
Adjusting the Image Size	42
Adjusting the Image Position	42
Adjusting the Horizontal Tilt	42
Correcting the Focus	43
Adjusting the Volume	43
Selecting the Projection Quality (Selecting Color Mode)	43
Setting Auto Iris	44
Changing the Aspect Ratio of the Projected Image	44
Changing methods	45
Changing the aspect mode	45



Useful Functions

Projection Functions 48

Projecting Two Images Simultaneously (Split Screen)	48
Input sources for split screen projection	48
Operating procedures	48
Restrictions during split screen projection	51
Projecting 3D Images	51
Preparing to view 3D images	51
Viewing 3D images	53
Converting 2D images to 3D images	54
Viewing area for 3D images	54
Warnings regarding viewing 3D images	55
Projecting Without a Computer (PC Free)	57
Specifications for files that can be projected using PC Free	58
PC Free examples	58
PC Free operating methods	58
Projecting the selected images or movies	61
Projecting image files in a folder in sequence (Slideshow)	61
Image file display settings and Slideshow operation settings	62
Projecting Using a QR Code	63
Setting the display method for QR codes	63
Projecting data from a smartphone or tablet device	64
Hiding the Image and Sound Temporarily (A/V Mute)	65
Freezing the Image (Freeze)	66
Pointer Function (Pointer)	66
Enlarging Part of the Image (E-Zoom)	67
Using the Remote Control to Operate the Mouse Pointer (Wireless Mouse)	68
Saving a User's Logo	69

Security Functions 71

Managing Users (Password Protect)	71
Kinds of Password Protect	71
Setting Password Protect	71
Entering the Password	72
Restricting Operation (Control Panel Lock)	73
Anti-Theft Lock	74
Installing the wire lock	74

Monitoring and Controlling 75

EasyMP Monitor	75
Message Broadcasting	75
Changing Settings Using a Web Browser (Web Control)	75
Projector setup	75
Displaying the Web Control screen	76
Displaying the Web Remote screen	76
Using the Mail Notification Function to Report Problems	77
Reading Error Notification Mail	77
Management Using SNMP	78
ESC/VP21 Commands	78
Before starting	78
Command list	79
Communications protocol	79

About Event ID 80

Configuration Menu

Using the Configuration Menu 82

List of Functions 83

Configuration Menu Table	83
Network menu	84
Image Menu	85
Signal Menu	85
Settings Menu	88
Extended Menu	89
Network Menu	90
Notes on operating the Network menu	91
Soft keyboard operations	91
Basic menu	92
Wireless LAN menu	93
Security menu	94
Mail menu	95
Others menu	96
Reset menu	97



ECO Menu 97
 Info Menu (Display Only) 98
 Reset Menu 99

Performing Batch Setup for Multiple Projectors 100

 Setup Using a USB Flash Drive 100
 Saving settings to the USB flash drive 100
 Reflecting saved settings to other projectors 102
 Setup by Connecting the Computer and Projector with a USB Cable 103
 Saving settings to a computer 104
 Reflecting saved settings to other projectors 105
 When Setup Fails 106

Troubleshooting

Using the Help 108

Problem Solving 110

 Reading the Indicators 110
 When the Indicators Provide No Help 114
 Problems Relating to Images 115
 No images appear 115
 Moving images are not displayed 116
 Projection stops automatically 116
 The message Not supported is displayed 116
 The message No Signal is displayed 117
 Cannot view 3D images 117
 Images are fuzzy, out of focus, or distorted 118
 Interference or distortion appear in images 118
 The image is truncated (large) or small, the aspect is not suitable, or the image has been reversed 119
 Image colors are not right 120
 Images appear dark 121
 Problems when Projection Starts 121
 The projector does not turn on 121
 Other Problems 122
 No sound can be heard or the sound is faint 122

There is noise in the audio (only when projecting USB display) 122
 The remote control does not work 123
 I want to change the language for messages and menus 123
 Mail is not received even if a problem occurs in the projector 123
 Cannot change settings using a Web browser 124

Maintenance

Cleaning 126

 Cleaning the Projector's Surface 126
 Cleaning the Lens 126
 Cleaning the 3D Glasses 126
 Cleaning the Air Filter 126

Replacing Consumables 128

 Replacing the Lamp 128
 Lamp replacement period 128
 How to replace the lamp 128
 Resetting the lamp hours 131
 Replacing the Air Filter 131
 Air filter replacement period 131
 How to replace the air filter 131

Appendix

Optional Accessories and Consumables 134

 Optional Accessories 134
 Consumables 135

Screen Size and Projection Distance 136

 Projection Distance 136

Supported Monitor Displays 138

 Supported Resolutions 138
 Computer signals (analog RGB) 138
 Component video 138



Composite video	138
HDMI Input Signal	138
MHL Input Signal	139
3D Input Signal (HDMI)	139
3D Input Signal (MHL)	139
Specifications	140
Projector General Specifications	140
Appearance	144
Glossary	145
General Notes	147
About Notations	147
General Notice:	148
Index	149



Introduction

This chapter explains the projector's features and the part names.

Project Realistic 3D Images

Project stunning 3D content from media such as 3D Blu-ray discs or 3D games. You need the optional active 3D Glasses (ELPGS03) to view 3D images.

☛ "Projecting 3D Images" p.51

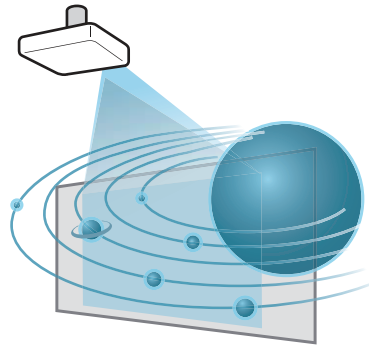

Quick and Easy Set up, Projection, and Storage

- Turn the projector on and off by simply plugging in or unplugging.
- Project onto large screens from a short distance.
- Make easy height adjustments with one lever.
- No cool down delay makes it easy to put away.
- Turn on the projector by simply receiving an image signal.

Connecting with a USB cable and projecting (USB Display)

By simply connecting a USB cable, you can project images from a computer's screen without a computer cable.

☛ "Projecting with USB Display" p.34

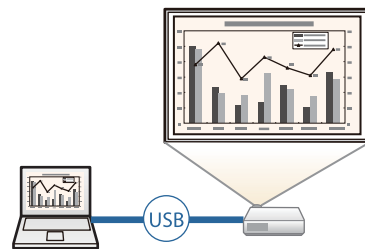

Detecting projector movements and automatically correcting image distortion

This projector automatically corrects vertical keystone distortion which occurs when positioning or moving the projector.

☛ "Correcting automatically" p.38

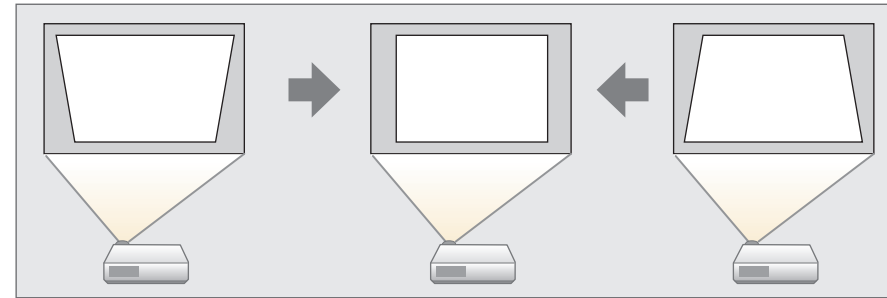

Horizontal keystone adjuster

This allows you to quickly correct horizontal distortion in the projected image. This is useful if you cannot install the projector parallel to the screen.

☛ "Correcting manually" p.39

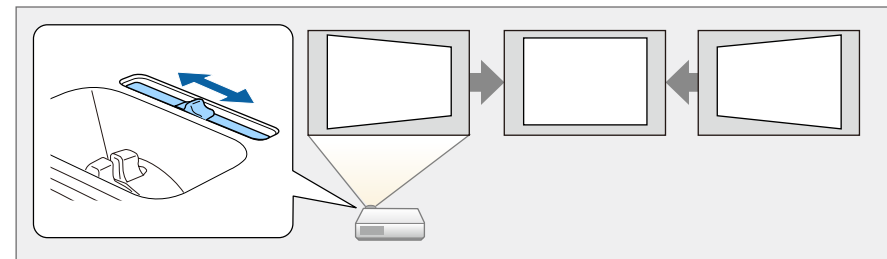

Useful Functions for Projecting Images

Project two images simultaneously (Split Screen)

This function divides the projected screen in two and projects two types of image side-by-side. By simultaneously projecting images from two sources on one screen, you can raise the impact of your message or proposition during video conferences or presentations.

☛ "Projecting Two Images Simultaneously (Split Screen)" [p.48](#)



Increasing projection content in wide (WXGA) screen

With a computer that has a 16:10 WXGA wide LCD display, the image can be projected in the same aspect. You can use whiteboards and other landscape format screens.

☛ "Changing the Aspect Ratio of the Projected Image" [p.44](#)

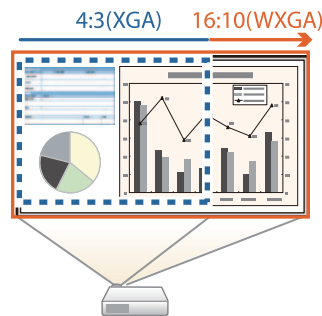

Connect a USB storage device and project movies or images (PC Free)

You can connect USB storage devices or digital cameras to the projector and project saved images.

A wide range of file formats are supported such as movies or images.

☛ "Projecting Without a Computer (PC Free)" [p.57](#)

Various functions for excellent power saving

- Various functions to prevent wasting electricity

The projector comes with a number of built-in functions to save power such as dimming the projected image, an auto power off timer, and adjusting power consumption while the projector is standing by.

☛ "ECO Menu" [p.97](#)

- Function for displaying the power-saving status on the projected screen
When ECO Display is set to **On** from the Configuration menu, leaf icons () that indicate the power-saving status are displayed at the bottom-left of the projected screen when the lamp brightness has switched to low brightness.

☛ ECO - ECO Display [p.97](#)

Making the most of the remote control

You can use the remote control to perform operations such as enlarging part of the image. You can also use the remote control as a pointer to draw attention to specific points, or as a mouse for the computer.

☛ "Pointer Function (Pointer)" [p.66](#)

☛ "Enlarging Part of the Image (E-Zoom)" [p.67](#)

☛ "Using the Remote Control to Operate the Mouse Pointer (Wireless Mouse)" [p.68](#)

Enlarge and project your files with the Document Camera

You can project paper documents and objects using the optional Document Camera.

By connecting to a computer and using the software supplied, you can make full use of the projector's capabilities.

☛ "Optional Accessories" [p.134](#)

Enhanced security functions

- **Password Protect to restrict and manage users**

By setting a Password you can restrict who can use the projector.

☛ "Managing Users (Password Protect)" [p.71](#)

- **Control Panel Lock to restrict button operation on the control panel**

You can use this to prevent people changing projector settings without permission at events, in schools, and so on.

☛ "Restricting Operation (Control Panel Lock)" [p.73](#)

- **Equipped with various anti-theft devices**

The projector is equipped with the following types of anti-theft security devices.

- Security slot
- Security cable installation point

☛ "Anti-Theft Lock" [p.74](#)

Connecting to a wireless LAN and projecting images

By installing the supplied or optional wireless LAN unit and connecting to a wireless LAN network, the following functions become available.

☛ "Installing the Wireless LAN Unit" [p.30](#)

- **Wirelessly projecting your computer's screen**

You can project your computer's screen over a network by using EasyMP Network Projection.

You can download EasyMP Network Projection from the following Web site.

<http://www.epson.com>



- **Projecting multiple computer screens at the same time**

By using EasyMP Multi PC Projection, you can project up to four screens at the same time from a computer on the network, or from smartphones or tablet devices on which Epson iProjection is installed.

You can download EasyMP Multi PC Projection from the following Web site.

<http://www.epson.com>

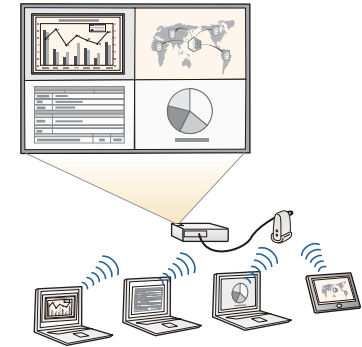

- **Using Quick Wireless Connection to make automatic network settings for your computer (Windows only)**

By simply connecting the optional Quick Wireless Connection USB Key to a computer, you can connect the projector and the computer using the wireless communication and project images from the computer.

☛ "Installing the Quick Wireless Connection USB Key" [p.30](#)

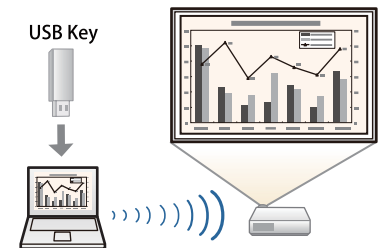

- **Projecting images from portable devices over a network**

If Epson iProjection is installed on your smart phone or tablet device, you can wirelessly project data from the device. This allows you to easily view images from a smart phone or tablet device.



You can download Epson iProjection for free from the App Store or from Google play. Any fees incurred when communicating with the App Store or Google play are the responsibility of the customer.

Front/Top

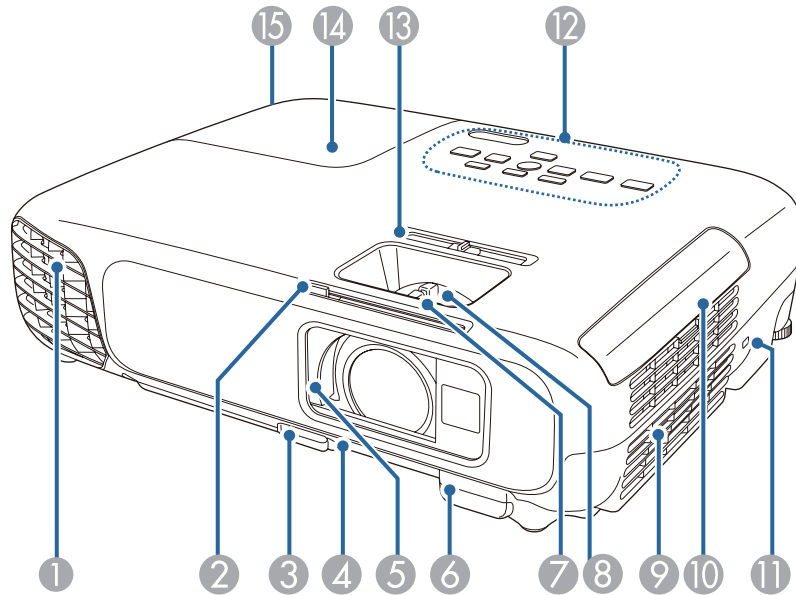

Name	Function
① Air exhaust vent	Exhaust vent for air used to cool the projector internally. <div style="border: 1px solid black; padding: 5px; background-color: #ffffcc;"> <p>⚠ Caution</p> <p>While projecting, do not put your face or hands near the air exhaust vent, and do not place objects that may become warped or damaged by heat near the vent. Hot air from the air exhaust vent could cause burns, warping, or accidents to occur.</p> </div>
② A/V mute slide knob	Slide the knob to open and close the A/V mute slide.
③ Foot adjust lever	Press the foot adjust lever to extend and retract the front adjustable foot. ☛ "Adjusting the Image Position" p.42

Name	Function
④ Front adjustable foot	When setup on a surface such as a desk, extend the foot to adjust the position of the image. ☛ "Adjusting the Image Position" p.42
⑤ A/V mute slide	Close when not using the projector to protect the lens. By closing during projection you can hide the image and the sound. ☛ "Hiding the Image and Sound Temporarily (A/V Mute)" p.65
⑥ Remote receiver	Receives signals from the remote control.
⑦ Focus ring	Adjusts the image focus. ☛ "Correcting the Focus" p.43
⑧ Zoom ring	Adjusts the image size. ☛ "Adjusting the Image Size" p.42
⑨ Air intake vent (air filter)	Takes in air to cool the projector internally. ☛ "Cleaning the Air Filter" p.126
⑩ Air filter cover	Opens and closes the air filter cover. ☛ "Replacing the Air Filter" p.131
⑪ Security slot	The security slot is compatible with the Microsaver Security System manufactured by Kensington. ☛ "Anti-Theft Lock" p.74
⑫ Control panel	Operates the projector. ☛ "Control Panel" p.14
⑬ Horizontal keystone adjuster	Corrects horizontal distortion in the projected image. ☛ "Correcting manually" p.39
⑭ Lamp cover	Open when replacing the projector's lamp. ☛ "Replacing the Lamp" p.128
⑮ Lamp Cover Fixing Screw	Screw to fix the lamp cover in place.

Rear

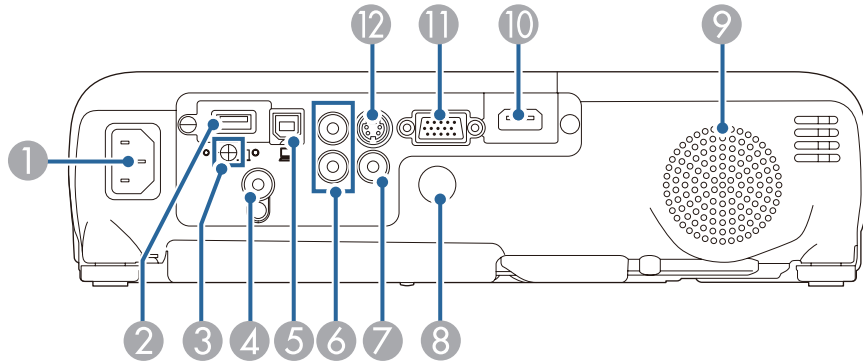

Name	Function
① Power inlet	Connects the power cord to the projector. ☛ "From Installation to Projection" p.32
② USB-A port	<ul style="list-style-type: none"> Connects a USB flash drive or a digital camera and projects movies or images using PC Free. ☛ "Projecting Without a Computer (PC Free)" p.57 Connects the optional Document Camera. Connects the supplied or optional Wireless LAN unit. ☛ "Installing the Wireless LAN Unit" p.30 Connects the optional Quick Wireless Connection USB Key. ☛ "Installing the Quick Wireless Connection USB Key" p.30
③ Wireless LAN unit fixing screw	This screw secures the wireless LAN unit cover.
④ Audio Out port	Outputs audio from the currently projected image to an external speaker.

Name	Function
⑤ USB-B port	<ul style="list-style-type: none"> Connects the projector to a computer using a USB cable, and projects the images on the computer. ☛ "Projecting with USB Display" p.34 Connects the projector to a computer using a USB cable to use the Wireless Mouse function. ☛ "Using the Remote Control to Operate the Mouse Pointer (Wireless Mouse)" p.68
⑥ Audio port	Inputs audio from equipment connected to the Computer port, the S-Video port, or the Video port.
⑦ Video port	Inputs composite video signals from video sources.
⑧ Remote receiver	Receives signals from the remote control.
⑨ Speaker	Outputs audio.
⑩ HDMI/MHL port	<ul style="list-style-type: none"> Inputs video signals from HDMI compatible video equipment and computers. This projector is compatible with HDCP. Inputs signals from smartphones and tablet devices that support MHL (Mobile High-definition Link). ☛ "Connecting Equipment" p.23
⑪ Computer port	Inputs image signals from a computer and component video signals from other video sources.
⑫ S-Video port	For S-video signals from video sources.

Base

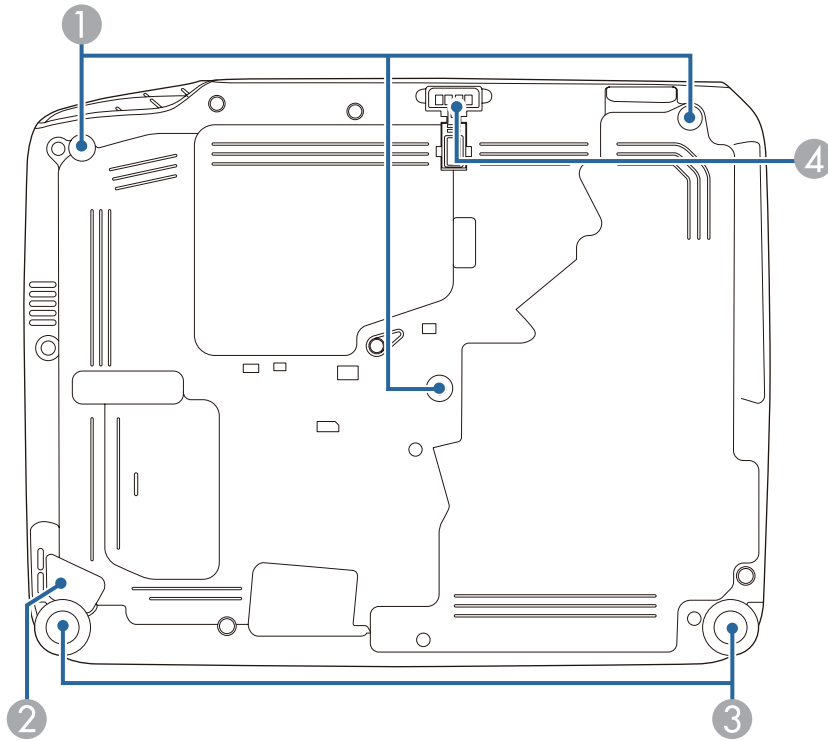

	Name	Function
③	Rear feet	When setup on a surface such as a desk, turn to extend and retract to adjust the horizontal tilt. ☛ "Adjusting the Horizontal Tilt" p.42
④	Front adjustable foot	When setup on a surface such as a desk, extend the foot to adjust the position of the image. ☛ "Adjusting the Image Position" p.42

	Name	Function
①	Ceiling mount fixing points (three points)	Attach the optional Ceiling Mount here when suspending the projector from a ceiling. ☛ "Installing the Projector" p.21 ☛ "Optional Accessories" p.134
②	Security cable installation point	Pass a commercially available wire lock through here and lock it in place. ☛ "Installing the wire lock" p.74

Control Panel

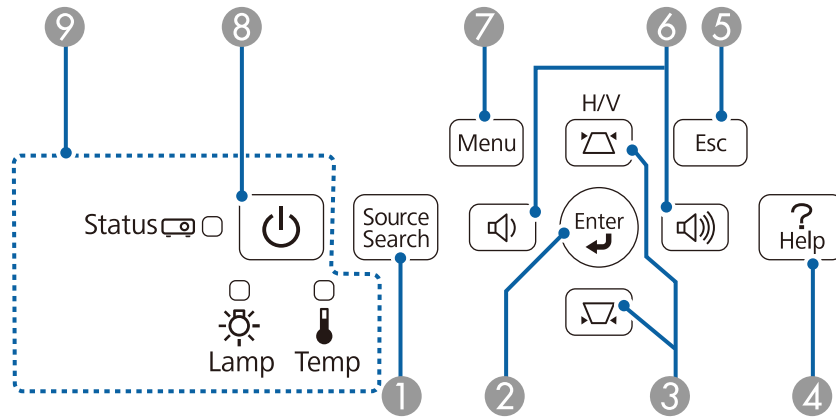

Name	Function
1 [Source Search] button	Changes to the next input source that is sending an image. ☛ "Automatically Detect Input Signals and Change the Projected Image (Source Search)" p.33
2 [Enter] button [↵]	<ul style="list-style-type: none"> When the Configuration menu or the Help screen is displayed, it accepts and enters the current selection and moves to the next level. If pressed while projecting analog RGB signals from the Computer port, you can automatically optimize Tracking, Sync., and Position.
3 [△][▽] buttons	<ul style="list-style-type: none"> Displays the Keystone screen allowing you to correct keystone distortion in vertical and horizontal directions. ☛ "Correcting manually" p.39 If pressed when the Configuration menu or the Help screen is displayed, these buttons select menu items and setting values. ☛ "Using the Configuration Menu" p.82 ☛ "Using the Help" p.108

Name	Function
4 [Help] button	Displays and closes the Help screen which shows you how to deal with problems if they occur. ☛ "Using the Help" p.108
5 [Esc] button	<ul style="list-style-type: none"> Stops the current function. If pressed when the Configuration menu is displayed, it moves to the previous menu level. ☛ "Using the Configuration Menu" p.82
6 [◀][▶] buttons	<ul style="list-style-type: none"> You can adjust the volume. [◀] Decreases the volume. [▶] Increases the volume. ☛ "Adjusting the Volume" p.43 Corrects keystone distortion in the horizontal direction when the Keystone screen is displayed. ☛ "H/V-Keystone" p.39 If pressed when the Configuration menu or the Help screen is displayed, these buttons select menu items and setting values. ☛ "Using the Configuration Menu" p.82 ☛ "Using the Help" p.108
7 [Menu] button	Displays and closes the Configuration menu. ☛ "Using the Configuration Menu" p.82
8 Power button [⏻]	Turns the projector power on or off. ☛ "From Installation to Projection" p.32
9 Indicators	Indicates the projector's status. ☛ "Reading the Indicators" p.110

Remote Control

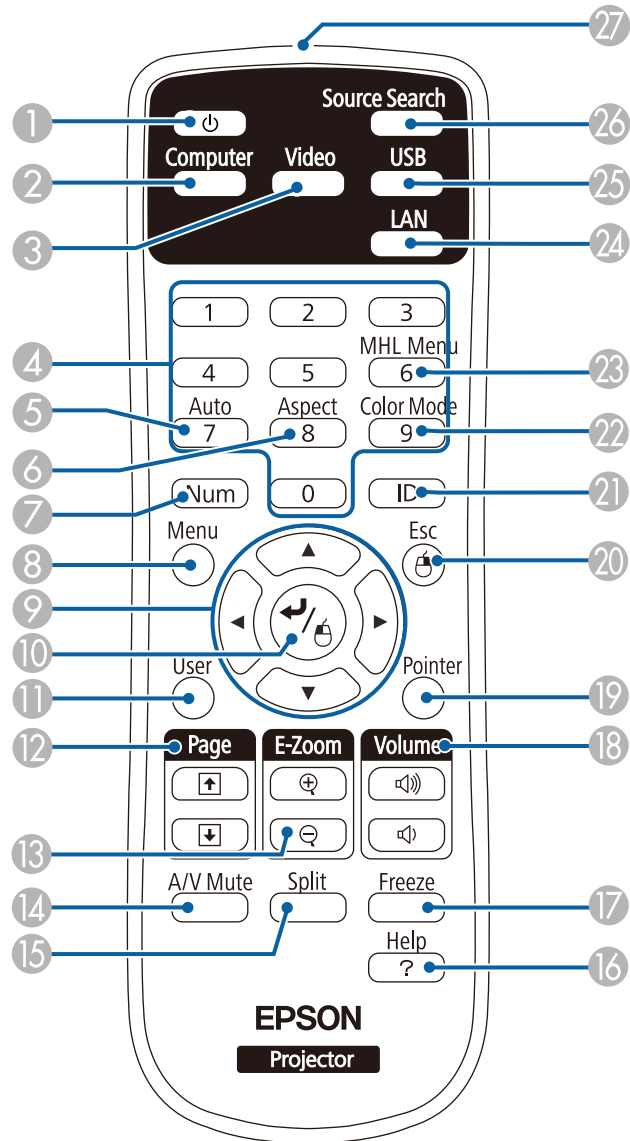

Name	Function
① Power button [⏻]	Turns the projector power on or off. ☛ "From Installation to Projection" p.32
② [Computer] button	Changes to images from the Computer port.
③ [Video] button	Each time the button is pressed, the image cycles through the S-Video, Video, and HDMI/MHL ports.
④ Numeric buttons	Enter the Password. ☛ "Setting Password Protect" p.71
⑤ [Auto] button	If pressed while projecting analog RGB signals from the Computer port, you can automatically optimize Tracking, Sync., and Position.
⑥ [Aspect] button	Each time the button is pressed, the aspect mode changes. ☛ "Changing the Aspect Ratio of the Projected Image" p.44
⑦ [Num] button	Hold down this button and press the numeric buttons to enter passwords and numbers. ☛ "Setting Password Protect" p.71
⑧ [Menu] button	Displays and closes the Configuration menu. ☛ "Using the Configuration Menu" p.82
⑨ [Navigation] buttons [Left] [Right] [Up] [Down]	<ul style="list-style-type: none"> • When the Configuration menu or the Help screen is displayed, pressing these buttons selects menu items and setting values. ☛ "Using the Configuration Menu" p.82 • When projecting using PC Free, pressing these buttons displays the previous/next image, rotates the image, and so on. ☛ "PC Free operating methods" p.58 • During Wireless Mouse function, the mouse pointer moves in the direction of the button that was pushed. ☛ "Using the Remote Control to Operate the Mouse Pointer (Wireless Mouse)" p.68

Name	Function
⑩ [↵] button	<ul style="list-style-type: none"> When the Configuration menu or the Help screen is displayed, it accepts and enters the current selection and moves to the next level. <ul style="list-style-type: none"> "Using the Configuration Menu" p.82 Acts as a mouse's left button when using the Wireless Mouse function. <ul style="list-style-type: none"> "Using the Remote Control to Operate the Mouse Pointer (Wireless Mouse)" p.68
⑪ [User] button	<p>Select any frequently used item from the seven available Configuration menu items, and assign it to this button. By pressing the [User] button, the assigned menu item selection/adjustment screen is displayed, allowing you to make one-touch settings/adjustments.</p> <ul style="list-style-type: none"> "Settings Menu" p.88 <p>Power Consumption is assigned as the default setting.</p>
⑫ [Page] buttons [↑][↓]	<p>Changes pages in files such as PowerPoint files when using the following projection methods.</p> <ul style="list-style-type: none"> When using the Wireless Mouse function <ul style="list-style-type: none"> "Using the Remote Control to Operate the Mouse Pointer (Wireless Mouse)" p.68 When using USB Display <ul style="list-style-type: none"> "Projecting with USB Display" p.34 <p>When projecting images using PC Free, pressing these buttons displays the previous/next screen.</p>
⑬ [E-Zoom] buttons [⊕][⊖]	<p>Enlarges or reduces the image without changing the projection size.</p> <ul style="list-style-type: none"> "Enlarging Part of the Image (E-Zoom)" p.67
⑭ [A/V Mute] button	<ul style="list-style-type: none"> Turns the video and audio on or off. <ul style="list-style-type: none"> "Hiding the Image and Sound Temporarily (A/V Mute)" p.65 You can change the Projection mode as follows by pressing the button for about five seconds. <ul style="list-style-type: none"> Front ↔ Front/Ceiling Rear ↔ Rear/Ceiling

Name	Function
⑮ [Split] button	<p>Each time the button is pressed, the image changes between projecting two images simultaneously by splitting the projected screen, or projecting one image as normal.</p> <ul style="list-style-type: none"> "Projecting Two Images Simultaneously (Split Screen)" p.48
⑯ [Help] button	<p>Displays and closes the Help screen which shows you how to deal with problems if they occur.</p> <ul style="list-style-type: none"> "Using the Help" p.108
⑰ [Freeze] button	<p>Images are paused or unpaused.</p> <ul style="list-style-type: none"> "Freezing the Image (Freeze)" p.66
⑱ [Volume] buttons [◀][▶]	<p>[◀] Decreases the volume. [▶] Increases the volume.</p> <ul style="list-style-type: none"> "Adjusting the Volume" p.43
⑲ [Pointer] button	<p>Displays the on-screen pointer.</p> <ul style="list-style-type: none"> "Pointer Function (Pointer)" p.66
⑳ [Esc] button	<ul style="list-style-type: none"> Stops the current function. If pressed when the Configuration menu is displayed, it moves to the previous level. <ul style="list-style-type: none"> "Using the Configuration Menu" p.82 Acts as a mouse's right button when using the Wireless Mouse function. <ul style="list-style-type: none"> "Using the Remote Control to Operate the Mouse Pointer (Wireless Mouse)" p.68
㉑ [ID] button	<p>The projector does not support this button's functions.</p>
㉒ [Color Mode] button	<p>Each time the button is pressed, the Color Mode changes.</p> <ul style="list-style-type: none"> "Selecting the Projection Quality (Selecting Color Mode)" p.43
㉓ [MHL Menu] button	<p>Displays the settings menu for the device linked to the projector's MHL port.</p>
㉔ [LAN] button	<p>Switches to the image from the network connected device.</p>

	Name	Function
25	[USB] button	Each time the button is pressed, it cycles through the following images: <ul style="list-style-type: none">• USB Display• Images from the device connected to the USB-A port
26	[Source Search] button	Changes to the next input source that is sending an image. ☞ "Automatically Detect Input Signals and Change the Projected Image (Source Search)" p.33
27	Remote control light-emitting area	Outputs remote control signals.

Replacing the remote control batteries

If delays in the responsiveness of the remote control occur or if it does not operate after it has been used for some time, it probably means that the batteries are becoming flat. When this happens, replace them with new batteries. Have two AA size manganese or alkaline batteries ready. You cannot use other batteries except for the AA size manganese or alkaline.

Attention

Make sure you read the following manual before handling the batteries.

 [Safety Instructions](#)

1 Remove the battery cover.

While pushing the battery compartment cover catch, lift the cover up.

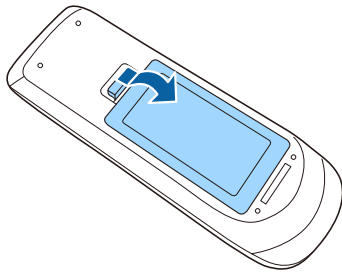

2 Replace the old batteries with new batteries.

Slide the batteries in negative side first.

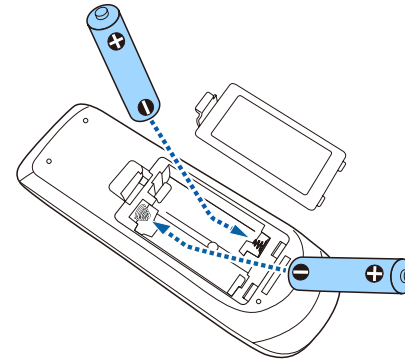

Caution

Check the positions of the (+) and (-) marks inside the battery holder to ensure the batteries are inserted the correct way.

If the batteries are not used correctly, they could explode or leak causing a fire, injury, or damage to the product.

3 Replace the battery cover.

Press the battery compartment cover until it clicks into place.

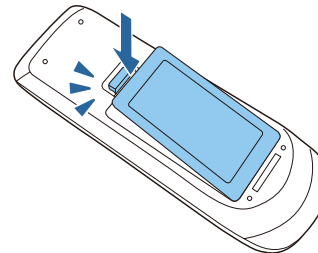

Remote control operating range

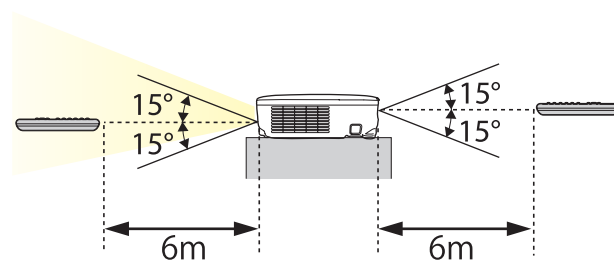
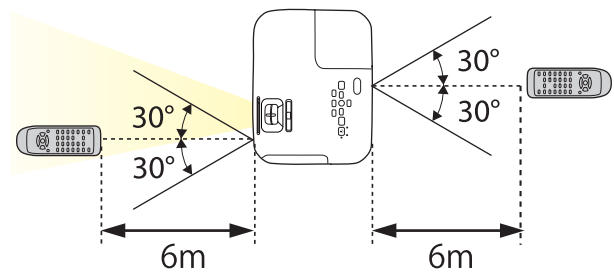



Preparing the Projector

This chapter explains how to install the projector and connect projection sources.

Installation Methods

The projector supports the following four different projection methods. Install the projector according to the conditions of the installation location.

- Project images from in front of the screen. (Front projection)

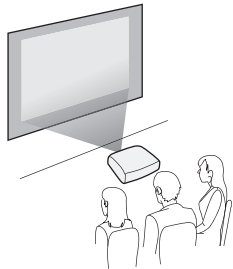

- Project images from behind a translucent screen. (Rear projection)

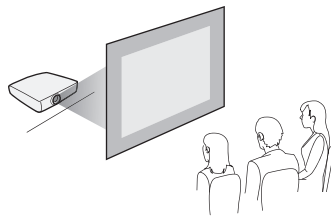

- Suspend the projector from the ceiling and project images from in front of a screen. (Front/Ceiling projection)

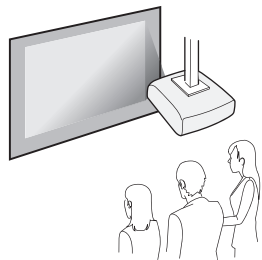

- Suspend the projector from the ceiling and project images from behind a translucent screen. (Rear/Ceiling projection)

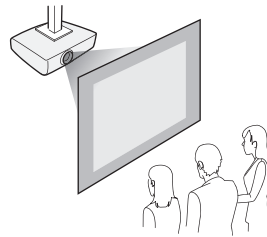

Warning

- A special method of installation is required when suspending the projector from a ceiling (ceiling mount). If it is not installed correctly, it could fall causing an accident and injury.
- If you use adhesives on the Ceiling mount fixing points to prevent the screws from loosening, or if you use things such as lubricants or oils on the projector, the projector case may crack causing it to fall from its ceiling mount. This could cause serious injury to anyone under the ceiling mount and could damage the projector. When installing or adjusting the ceiling mount, do not use adhesives to prevent the screws from loosening and do not use oils or lubricants and so on.
- Do not cover the projector's air intake vent or air exhaust vent. If either of the vents are covered, the internal temperature could rise and cause a fire.

Attention

Do not use the projector on its side. This may cause malfunctions to occur.



- An optional Ceiling mount is required when suspending the projector from a ceiling.
 - "Optional Accessories" [p.134](#)
- The default Projection setting is **Front**. You can change from **Front** to **Rear** from the Configuration menu.
 - **Extended - Projection** [p.89](#)
- You can change the Projection mode as follows by pressing down the [A/V Mute] button on the remote control for about five seconds.
 - Front ↔ Front/Ceiling**
 - Rear ↔ Rear/Ceiling**

Installation methods

Install the projector as follows.

- Install the projector so that it is parallel to the screen.
If the projector is installed at an angle to the screen, keystone distortion occurs in the projected image.

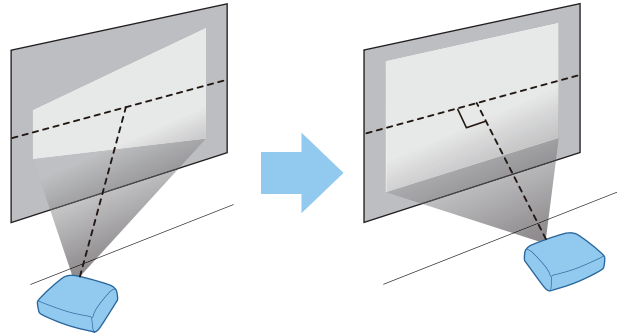

- Place the projector on a level surface.
If the projector is tilted the projected image is also tilted.

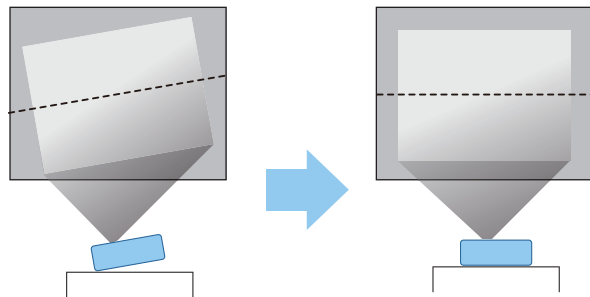

- See the following if you cannot install the projector parallel to the screen.
 - ☛ "Correcting Keystone Distortion" [p.38](#)
- See the following if you cannot install the projector on a level surface.
 - ☛ "Adjusting the Horizontal Tilt" [p.42](#)
 - ☛ "Correcting Keystone Distortion" [p.38](#)

Screen Size and Approximate Projection Distance

Projection size is determined by the distance from the projector to the screen. See the illustrations on the right to select the best position according to the screen size. The illustrations show the approximate shortest distance at maximum zoom. See the following for more information on the projection distance.

☛ "Screen Size and Projection Distance" [p.136](#)



When you correct keystone distortion, the projected image may be reduced.

16:10 Screen Size

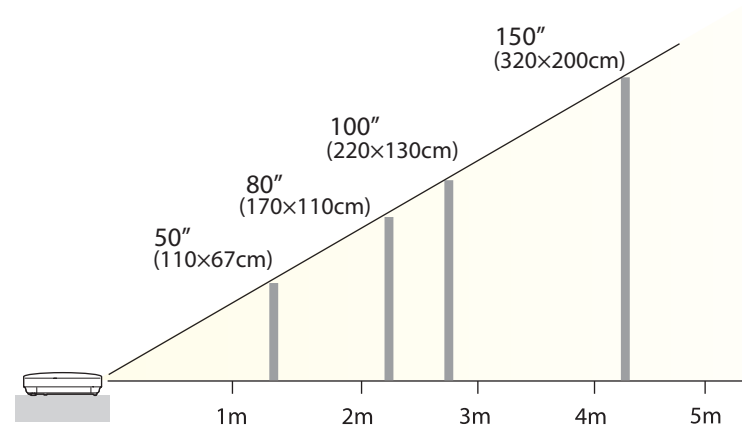

The port name, location, and connector orientation differ depending on the source being connected.

Connecting Image Sources

To project images from DVD players or game consoles and so on, connect to the projector using one of the following methods.

① **When using a commercially available HDMI cable**

Connect the HDMI port on the image source to the projector's HDMI/MHL port. You can send the image source's audio with the projected image.

② **When using the optional component video cable**

☛ "Optional Accessories" [p.134](#)

Connect the component output port on the image source to the projector's Computer input port. You can output audio from the projector's speaker by connecting the audio output port on the image source to the projector's Audio port using a commercially available audio cable.

③ **When using a commercially available video or S-video cable**

Connect the video output port on the image source to the projector's Video port. Or, connect the S-video output port on the image source to the projector's S-Video port. You can output audio from the projector's speaker by connecting the audio output port on the image source to the projector's Audio port using a commercially available audio cable.

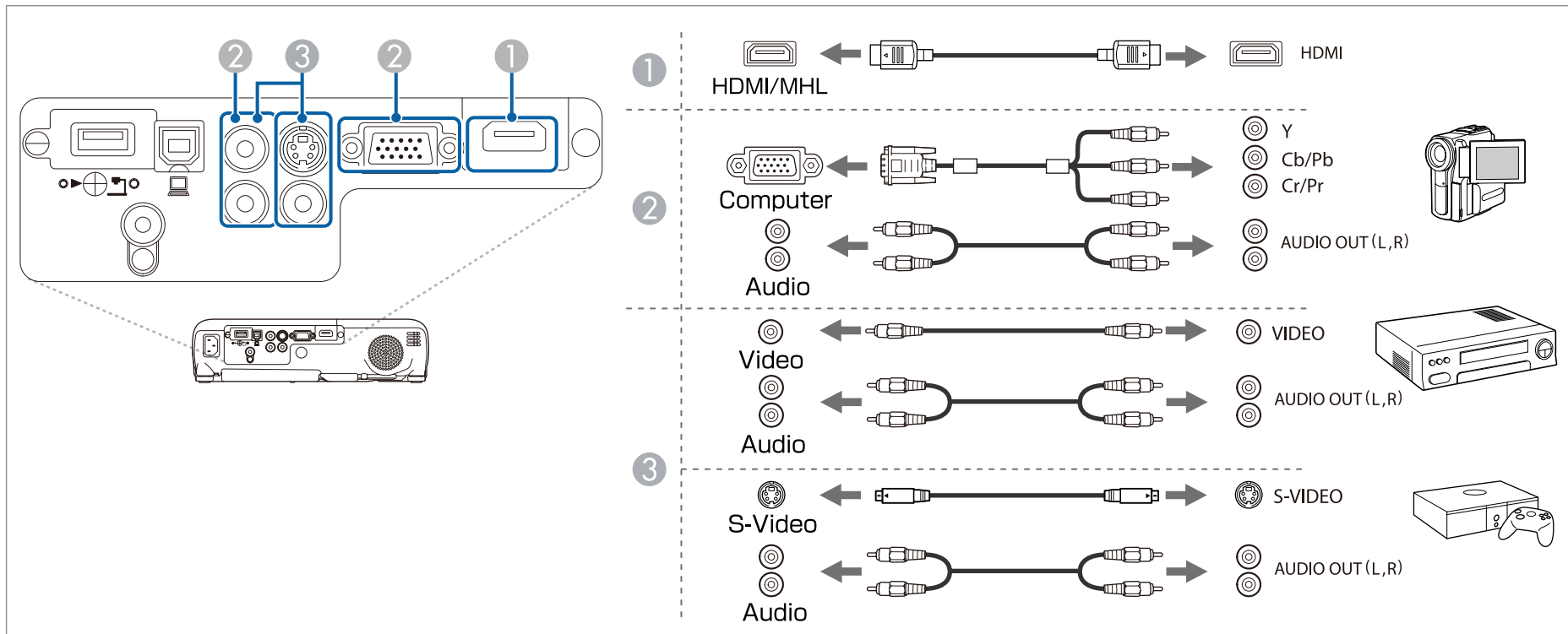

Attention

- Turn off the equipment you want to connect before connecting. If the input source is on when you connect it to the projector, it could cause a malfunction.
- If the orientation or shape of the plug differs, do not try to force it in. The device could be damaged or could malfunction.



- Use an HDMI cable that meets the HDMI standards.
- If the source you want to connect to has an unusually shaped port, use the cable supplied with the device or an optional cable to connect to the projector.
- The cable to be connected to the projector varies depending on the type of video signal being output by the video equipment. The video equipment may be able to output different types of video signal. The following shows standard image resolutions, from the highest resolution to the lowest.
Component video > S-video > Composite video
See the documentation supplied with the video equipment to check what types of video signal it can output. Composite video may be listed as "video output".
- When a game console is connected, the projected image may be slightly delayed when operating the game console.
 - ☛ "Selecting the Projection Quality (Selecting Color Mode)" [p.43](#)
- When using a commercially available 2RCA(L/R)/stereo mini-pin audio cable, make sure it is labeled "No resistance".

Connecting a Computer

To project images from a computer, connect the computer using one of the following methods.

① **When using the optional or commercially available computer cable**

Connect the computer's display output port to the projector's Computer port. You can output audio from the projector's speaker by connecting the audio output port on the computer to the projector's Audio port using a commercially available audio cable.

② **When using a commercially available USB cable**

Connect the computer's USB port to the projector's USB-B port. You can send the computer's audio with the projected image.

③ **When using a commercially available HDMI cable**

Connect the HDMI port on the computer to the projector's HDMI/MHL port. You can send the computer's audio with the projected image.

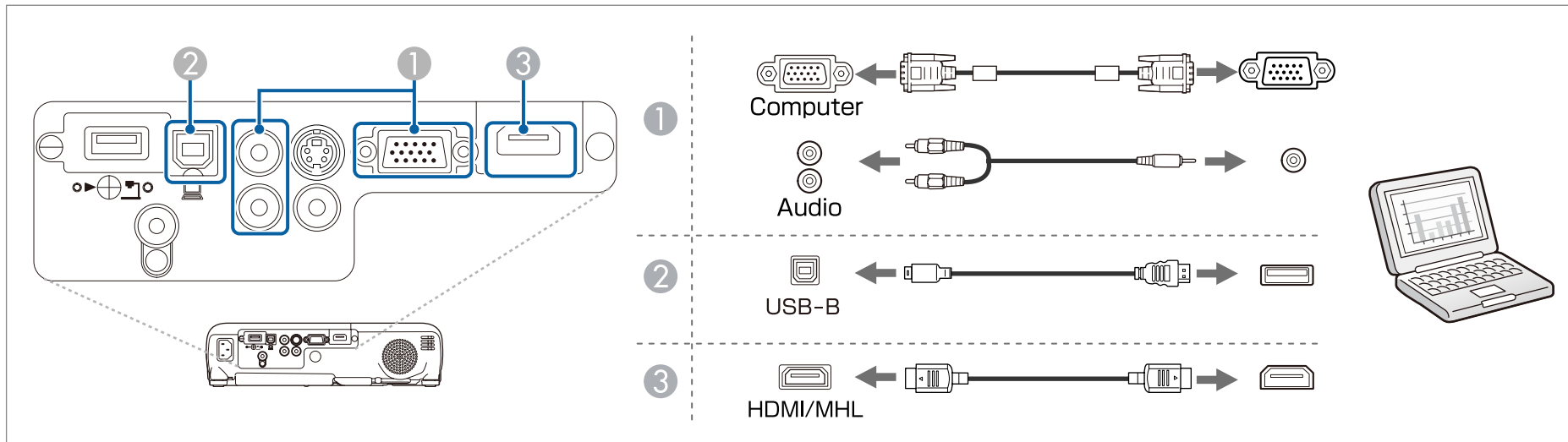

You can use a USB cable to connect the projector to a computer to project images from the computer. This function is called USB Display.

☛ "Projecting with USB Display" [p.34](#)

Connecting a Smartphone or Tablet Device

You can connect smartphones and tablet devices. By using a commercially available MHL cable, you can connect the MHL port on your device to the HDMI/MHL port on the projector. You can send the audio with the projected image.

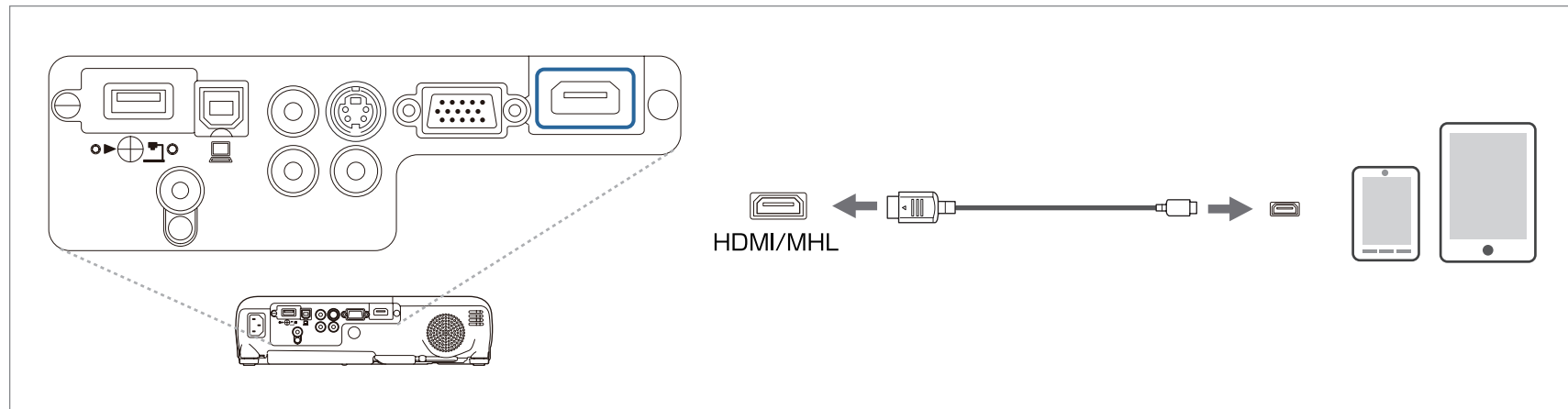

When you connect a smartphone or tablet device to the projector, the device starts charging when images are projected.

Attention

- You may not be able to connect an MHL cable to all devices.
- Make sure the connection cable supports the MHL standards. If you connect a cable that does not support the MHL standards, the smartphone or tablet device may become hot, leak, or explode.
- If you connect using an MHL-HDMI conversion adapter, charging the smartphone or tablet device may not work or you may not be able to perform operations from the projector's remote control.



- If images are not projected correctly, disconnect and then reconnect the MHL cable.
- You may not be able to project correctly depending on the model and settings of the smartphone or tablet device.

Connecting USB Devices

You can connect devices such as the optional Document Camera, a USB flash drive, and USB compatible hard disks and digital cameras.

Using the USB cable supplied with the USB device, connect the USB device to the USB-A port on the projector.

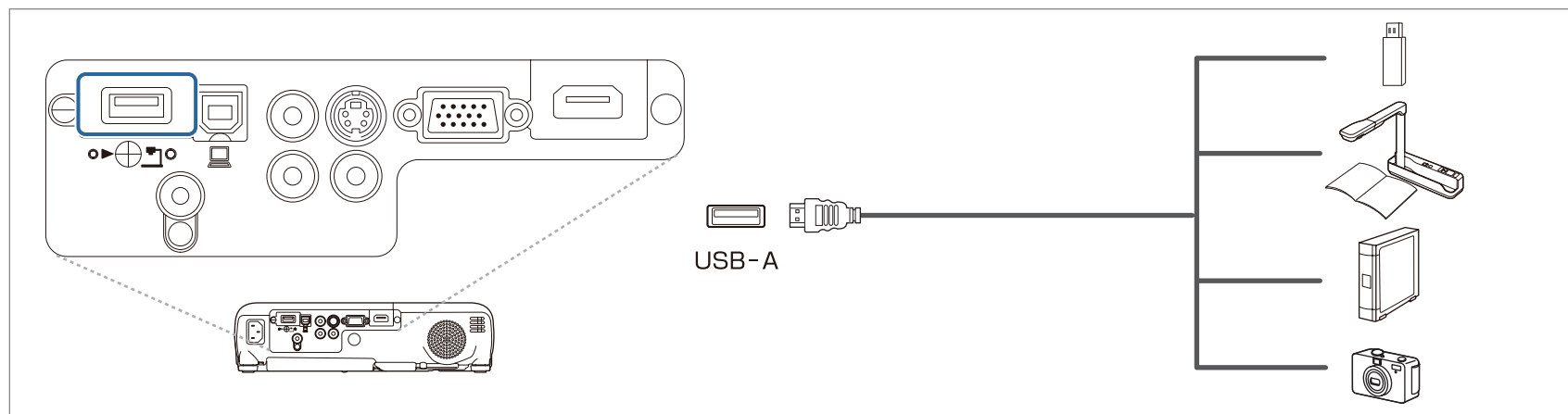

When the USB device is connected, you can project image files on the USB flash drive or digital camera using PC Free.

☞ "PC Free examples" [p.58](#)

Attention

- If you use a USB hub, the connection may not operate correctly. Devices such as digital cameras and USB devices should be connected to the projector directly.
- When connecting and using a USB-compatible hard disk, make sure you connect the AC adaptor supplied with the hard disk.
- Connect a digital camera or hard disk to the projector using a USB cable supplied with or specified for use with the device.
- Use a USB cable less than three meters in length. If the cable exceeds three meters, PC Free may not function correctly.

Removing USB devices

After finishing projecting, remove USB devices from the projector. For devices such as digital cameras or hard disks, turn off the device and then remove it from the projector.

Connecting External Equipment

You can output audio by connecting an external speaker.

Connect the external speaker to the projector's Audio Out port using a commercially available audio cable.

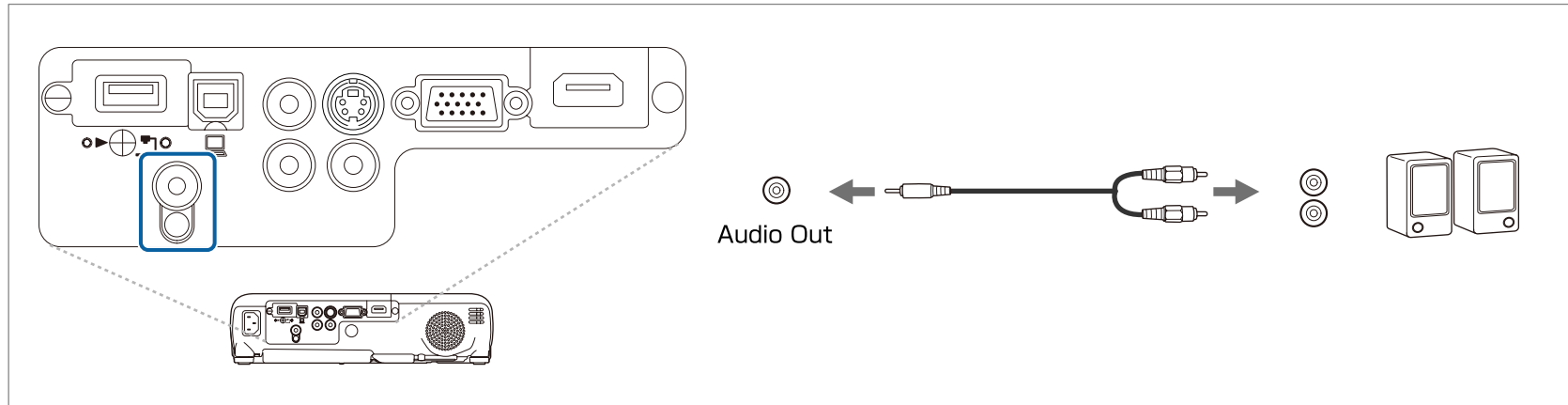

When the audio cable jack is inserted into the Audio Out port, audio stops being output from the projector's built-in speakers and switches to external output.

Installing the Wireless LAN Unit

By installing the supplied or optional wireless LAN unit, you can project the computer screen that is connected to the wireless LAN over a network.

Connect the wireless LAN unit to the projector's USB-A port.



- When connecting to the network using wireless LAN, make sure you make network settings from the Configuration menu.
 ☛ "Wireless LAN menu" p.93
- When moving the projector, make sure you remove the wireless LAN unit for safety reasons.

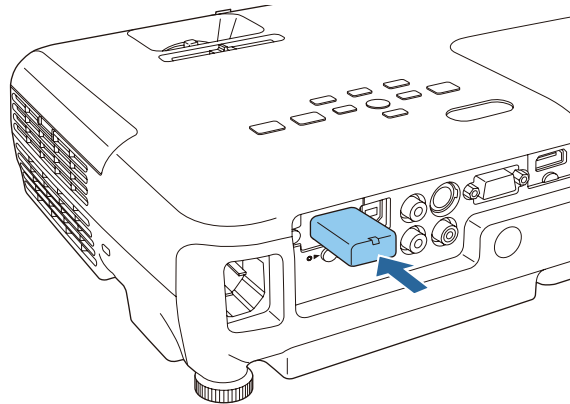

Installing the Quick Wireless Connection USB Key

When installing the optional Quick Wireless Connection USB Key, you need to remove the Wireless LAN unit first, and then connect the Quick Wireless Connection USB Key to the USB-A port.

- 1** If the Wireless LAN unit is installed on the projector, press the [LAN] button on the remote control.
The LAN standby screen is displayed.
- 2** Check that the SSID and IP address information are displayed on the LAN standby screen, and then remove the Wireless LAN unit.
- 3** Connect the Quick Wireless Connection USB Key to the USB-A port.

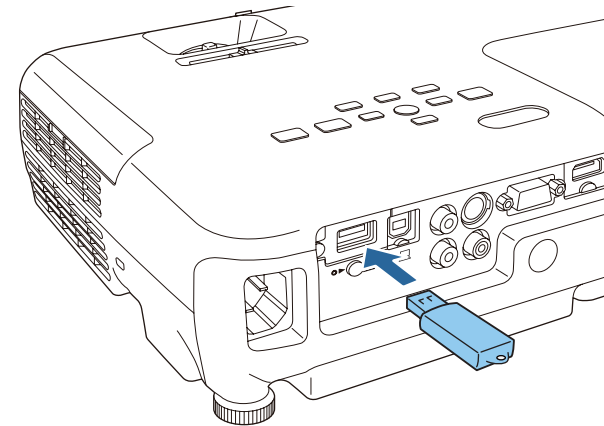

- 4** When the message "Network information update complete. Remove the Quick Wireless Connection USB Key Adapter." is displayed, remove the Quick Wireless Connection USB Key.
- 5** Reinstall the Wireless LAN unit on the projector.
- 6** Connect the Quick Wireless Connection USB Key to the computer you are using.
For the steps from here on, see the User's Guide supplied with the Quick Wireless Connection USB Key.



Basic Usage

This chapter explains how to project and adjust images.

From Installation to Projection

This section explains how to connect video equipment to the projector with an HDMI cable and project images.

Attention

Make sure you connect the cable from the source to the projector first, and then connect the power cord to the projector.

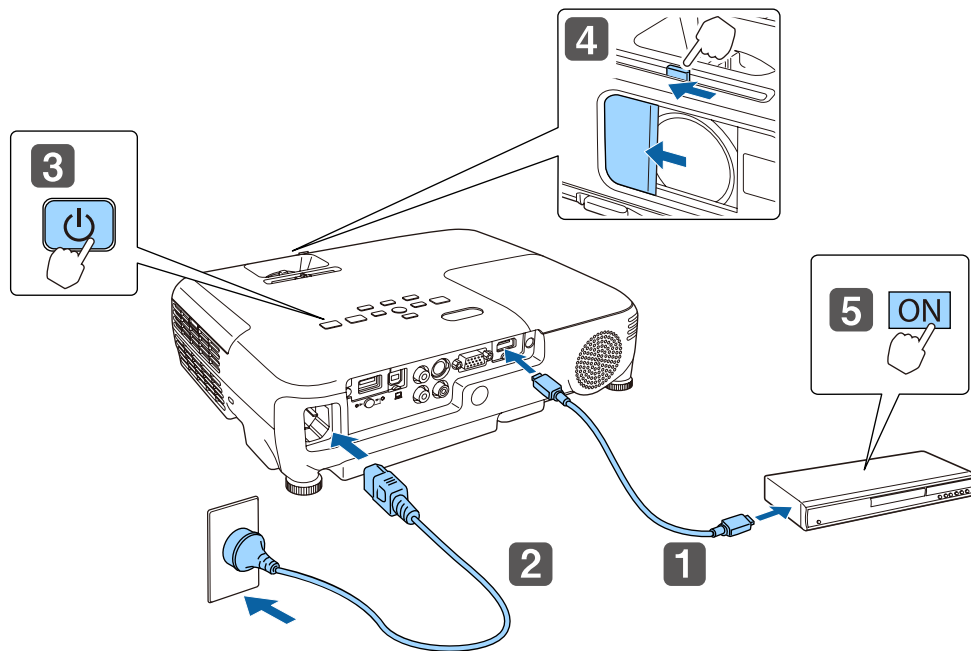

- 1 Connect the projector to the video equipment with an HDMI cable.
- 2 Connect the projector to an electrical outlet with the power cord.
- 3 Turn on the projector.

4 Open the A/V mute slide.

5 Turn on the video equipment.

If the image is not projected, you can change the projected image using one of the following methods.

- Press the [Source Search] button on the control panel or the remote control.
 - ☛ "Automatically Detect Input Signals and Change the Projected Image (Source Search)" [p.33](#)
- Press the button for the target port on the remote control.
 - ☛ "Switching to the Target Image by Remote Control" [p.34](#)



- After projecting the image, adjust the image if necessary.
 - ☛ "Correcting Keystone Distortion" [p.38](#)
 - ☛ "Correcting the Focus" [p.43](#)
- When turning off the projector, press the [⏻] power button twice.

Automatically Detect Input Signals and Change the Projected Image (Source Search)

Press the [Source Search] button to project images from the port currently receiving an image.

Using the remote control

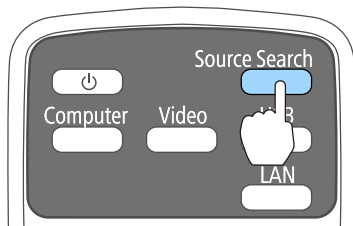

Using the control panel

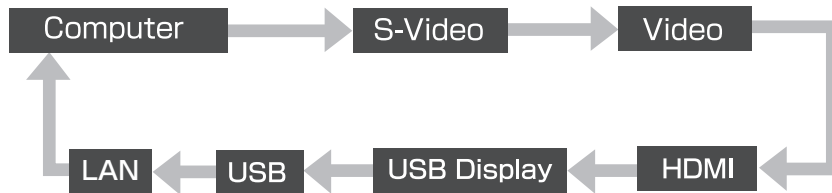
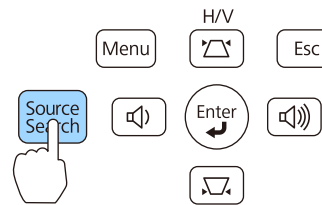

When two or more image sources are connected, press the [Source Search] button until the target image is projected.

When your video equipment is connected, start playback before beginning this operation.



The following screen is displayed while no image signals are input.

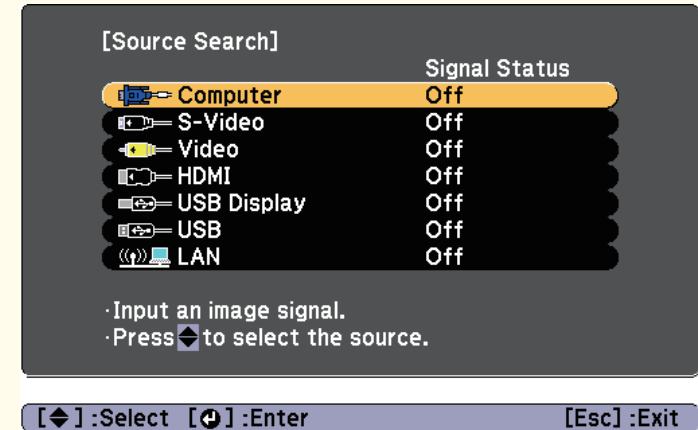

Switching to the Target Image by Remote Control

You can change directly to the target image by pressing the following buttons on the remote control.

Remote control

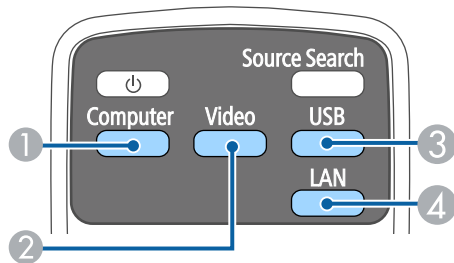

- ① Switches to images from the Computer port.
- ② Each time the button is pressed, it cycles through the images being input from the following sources.
 - S-Video port
 - Video port
 - HDMI/MHL port
- ③ Each time the button is pressed, it cycles through the images being input from the following sources.
 - USB Display
 - Images from the device connected to the USB-A port
- ④ Switches to the image from the network connected device.

Projecting with USB Display

You can use a USB cable to connect the projector to a computer to project images from the computer.

You can project images and send audio with one USB cable.

To start USB Display, set **USB Type B** to **USB Display** from the Configuration menu.

☛ **Extended - USB Type B** [p.89](#)

System requirements

For Windows

OS	Windows 2000*1	
	Windows XP*2	Professional 32bit Home Edition 32bit Tablet PC Edition 32bit
	Windows Vista	Ultimate 32bit Enterprise 32bit Business 32bit Home Premium 32bit Home Basic 32bit
	Windows 7	Ultimate 32/64bit Enterprise 32/64bit Professional 32/64bit Home Premium 32/64bit Home Basic 32bit Starter 32bit
	Windows 8	Windows 8 32/64 bit Windows 8 Pro 32/64 bit Windows 8 Enterprise 32/64 bit

	Windows 8.1	Windows 8.1 32/64 bit Windows 8.1 Pro 32/64 bit Windows 8.1 Enterprise 32/64 bit
CPU	Mobile Pentium III 1.2 GHz or faster Recommended: Pentium M 1.6 GHz or faster	
Amount of Memory	256 MB or more Recommended: 512 MB or more	
Hard Disk Space	20 MB or more	
Display	Resolution of no less than 640x480 and no higher than 1600x1200. Display color in 16-bit color or greater	

*1 Service Pack 4 only

*2 Except for Service Pack 1

For OS X

OS	Mac OS 10.5.x 32 bit Mac OS 10.6.x 32/64 bit OS X 10.7.x 32/64 bit OS X 10.8.x OS X 10.9.x
CPU	Power PC G4 1GHz or faster Recommended: Core Duo 1.83GHz or faster
Amount of Memory	512 MB or more
Hard Disk Space	20 MB or more
Display	Resolution of no less than 640x480 and no higher than 1680x1200. Display color in 16-bit color or greater

Connecting for the first time

The first time you connect the projector and the computer using the USB cable, the driver needs to be installed. The procedure is different for Windows and OS X.



- You do not need to install the driver the next time you connect.
- When inputting images from multiple sources, change the input source to USB Display.
- If you use a USB hub, the connection may not operate correctly. Connect the USB cable directly to the projector.
- You cannot change option settings while using USB Display.

For Windows

- 1** Connect the computer's USB port to the projector's USB-B port using a USB cable.



For Windows 2000 or Windows XP, a message asking you if you want to restart your computer may be displayed. Select **No**.

For Windows 2000

Double-click **Computer**, **EPSON PJ_UD**, and then **EMP_UDSE.EXE**.

For Windows XP

Driver installation starts automatically.

For Windows Vista/Windows 7/Windows 8/Windows 8.1

When the dialog box is displayed, click **Run EMP_UDSE.exe**.

- 2** When the License Agreement screen is displayed, click **Agree**.

- 3** Computer images are projected.
It may take a while before computer images are projected. Until computer images are projected, leave the equipment as it is and do not disconnect the USB cable or turn off the power to the projector.
- 4** Disconnect the USB cable when you finish projection.
When disconnecting the USB cable, there is no need to use **Safely Remove Hardware**.



- If it is not installed automatically, double-click **My Computer - EPSON_PJ_UD - EMP_UDSE.EXE** on your computer.
- If nothing is projected for some reason, click **All Programs - EPSON Projector - Epson USB Display - Epson USB Display Vx.xx** on your computer.
- When using a computer running Windows 2000 under user authority, a Windows error message is displayed and you may not be able to use the software. In this case, try updating Windows to the latest version, restart, and then try to connect again.
For more details, contact your local dealer or the nearest address provided in the following document.
 [Epson Projector Contact List](#)

For OS X

- 1** Connect the computer's USB port to the projector's USB-B port using a USB cable.
The Setup folder of USB Display is displayed in the Finder.
- 2** Double-click the **USB Display Installer** icon.
- 3** Follow the on-screen instructions to install.

- 4** When the License Agreement screen is displayed, click **Agree**.
Enter the administrator authority password and start the installation.
When the installation is complete, the USB Display icon is displayed in the Dock and menu bar.
- 5** Computer images are projected.
It may take a while before computer images are projected. Until computer images are projected, leave the equipment as it is and do not disconnect the USB cable or turn off the power to the projector.
- 6** When you finish projection, select **Disconnect** from the **USB Display** icon menu on the menu bar or Dock, and then remove the USB cable.



- If the USB Display setup folder is not displayed automatically in the Finder, double-click **EPSON PJ_UD - USB Display Installer** on your computer.
- If nothing is projected for some reason, click the **USB Display** icon in the Dock.
- If there is no **USB Display** icon in the Dock, double-click **USB Display** from the Applications folder.
- If you select **Exit** from the **USB Display** icon menu on the Dock, USB Display does not start automatically when you connect the USB cable.

Uninstalling

For Windows 2000

- 1** Click **Start**, select **Settings**, and then click **Control Panel**.
- 2** Double-click **Add/Remove Programs**.
- 3** Click **Change or Remove Programs**.
- 4** Select **Epson USB Display** and click **Change/Remove**.

For Windows XP

- 1 Click **Start**, and then click **Control Panel**.
- 2 Double-click **Add or Remove Programs**.
- 3 Select **Epson USB Display** and click **Remove**.

For Windows Vista/Windows 7

- 1 Click **Start**, and then click **Control Panel**.
- 2 Click **Uninstall a program** under **Programs**.
- 3 Select **Epson USB Display** and click **Uninstall**.

For Windows 8/Windows 8.1

- 1 Open Charms, and then select **Search**. Right-click (press and hold) **Epson USB Display Ver.XXX**.
- 2 Select **Uninstall** from the app bar.
- 3 Select **Epson USB Display**, and then select **Uninstall**.
- 4 Follow the on-screen instructions to uninstall.

For OS X

- 1 Open the **Applications** folder, double-click **USB Display**, and then double-click **Tool**.
- 2 Run **USB Display Uninstaller**.

Correcting Keystone Distortion

You can correct keystone distortion using one of the following methods.

- Correcting automatically (Auto V-Keystone)
Automatically corrects vertical keystone distortion.
- Correcting manually (H-Keystone Adjuster)
Manually corrects horizontal keystone distortion using the horizontal keystone adjuster.

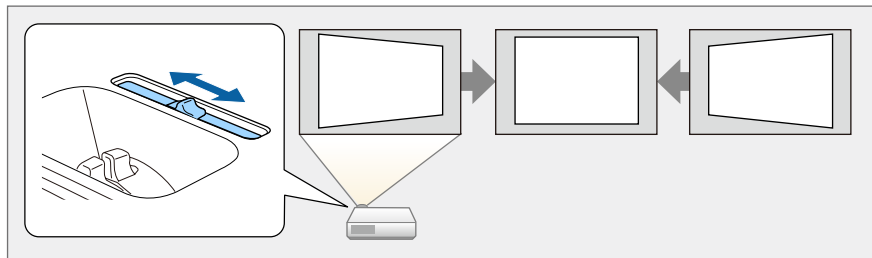

- Correcting manually (H/V-Keystone)
Manually correct distortion in the horizontal and vertical directions independently.

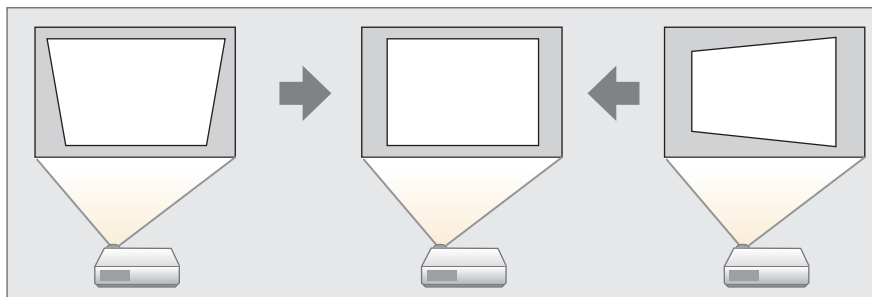

- Correcting manually (Quick Corner)
Manually correct the four corners independently.

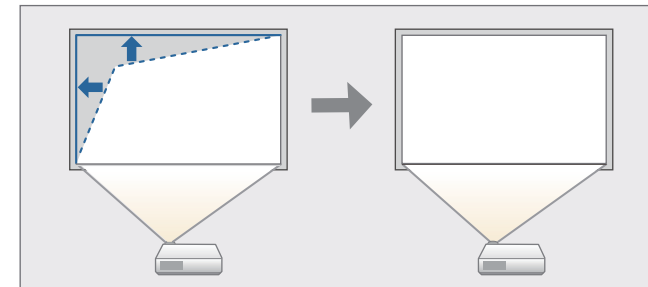

When you correct keystone distortion, the projected image may be reduced.

Correcting automatically

Auto V-Keystone

When the projector detects any movement, for example when it is installed, moved, or tilted, it automatically corrects vertical keystone distortion. This function is called Auto V-Keystone.

When the projector is moved, it displays a screen for adjustment and then automatically corrects the projected image.

You can use Auto V-Keystone to correct the projected image under the following conditions.

Correction angle: approx. 30° up and down



- Auto V-Keystone works only when **Projection** is set to **Front** from the Configuration menu.
 - ☛ **Extended - Projection** p.89
- If you do not want to enable Auto V-Keystone, set **Auto V-Keystone** to **Off**.
 - ☛ **Settings - Keystone - H/V-Keystone - Auto V-Keystone** p.88



- When using horizontal keystone adjuster, set **H-Keystone Adjuster** to **On**.
 - ☛ **Settings - Keystone - H/V-Keystone - H-Keystone Adjuster** p.88
- You can also correct keystone distortion in the horizontal direction using H/V-Keystone.

Correcting manually

You can manually correct keystone distortion.

You can use H/V-Keystone to correct the projected image under the following conditions.

Correction angle: approx. 30° right and left/approx. 30° up and down

H-Keystone Adjuster

Move the horizontal keystone adjuster to the right or left to perform horizontal keystone correction.

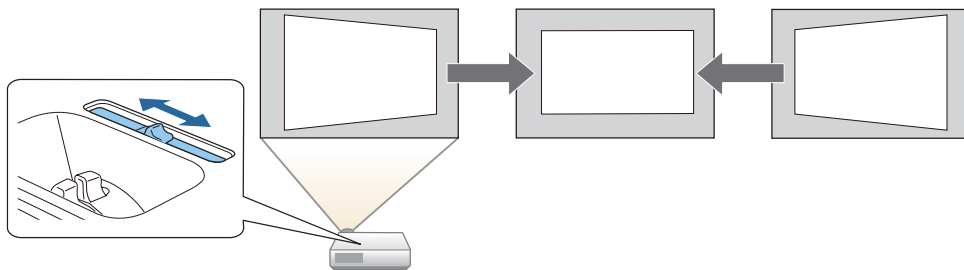

H/V-Keystone

Manually correct distortion in the horizontal and vertical directions independently.

- 1 Press the [▽] or [△] button on the control panel during projection to display the Keystone screen.

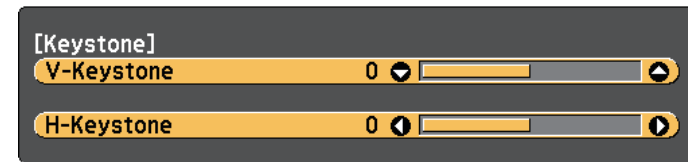

[◆] :V-Keystone [◀▶] :H-Keystone

- 2 Press the following buttons to correct keystone distortion. Press the [▽] or [△] button to correct vertical distortion.

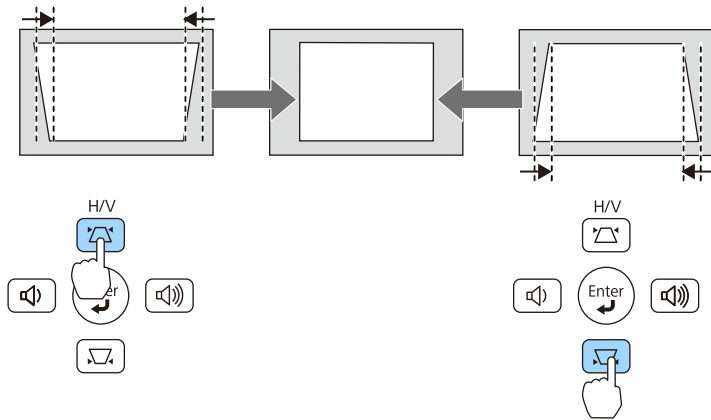

Press the [◀]/[▶] buttons to correct horizontal distortion.

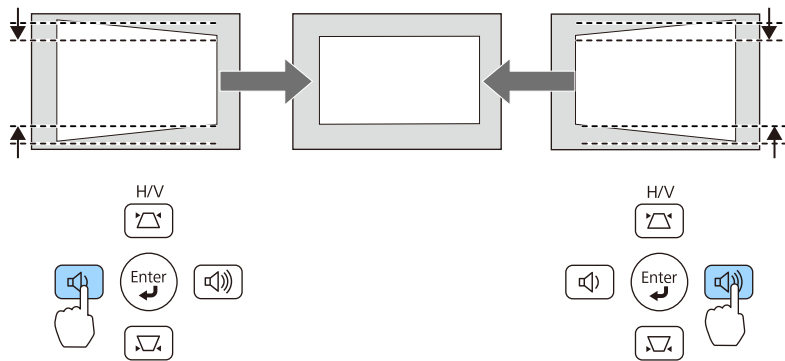

You can also set H/V-Keystone from the Configuration menu.

☛ **Settings - Keystone - H/V-Keystone** [p.88](#)

Quick Corner

This allows you to manually correct each of the four corners of the projected image separately.

1 Press the [Menu] button while projecting.

☛ "Using the Configuration Menu" [p.82](#)

Using the remote control

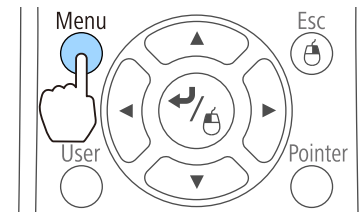

Using the control panel

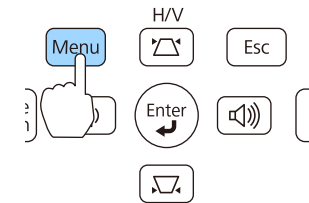

2 Select **Keystone** from **Settings**.

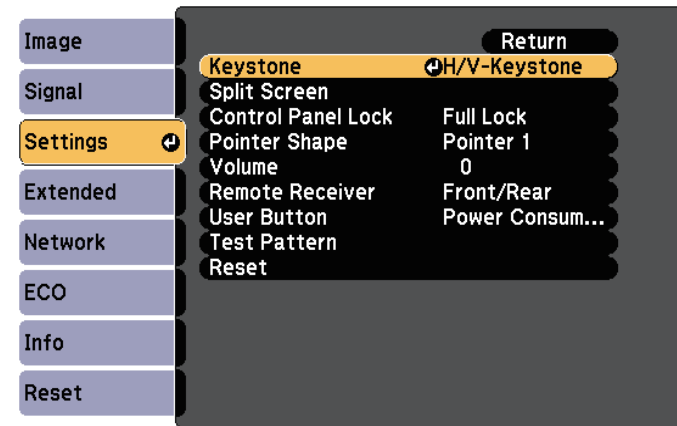

[Esc]:Return [◀]:Select [▶]:Enter [Menu]:Exit

3 Select **Quick Corner**, and then press the [↵] button.



[Esc]:Return [Left Arrow]:Select [Right Arrow]:Enter [Menu]:Exit

- 4** Using the [Up], [Down], [Left], and [Right] buttons on the remote control, or the [Z], [V], [Left], and [Right] buttons on the control panel, select the corner to correct, and then press the [Left] button.

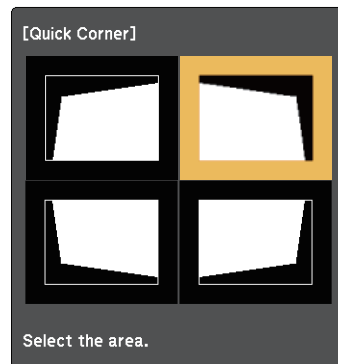

[Left Arrow / Right Arrow]:Select
 [Right Arrow]:Enter
 [Esc]:Return (press for 2 seconds to reset/switch)

- 5** Using the [Up], [Down], [Left], and [Right] buttons on the remote control, or the [Z], [V], [Left], and [Right] buttons on the control panel, correct the position of the corner.

When you press the [Left] button, the screen shown in step 4 that allows you to select the area to be corrected is displayed.

If the message "Cannot adjust any further." is displayed while adjusting, you cannot adjust the shape any further in the direction indicated by the gray triangle.

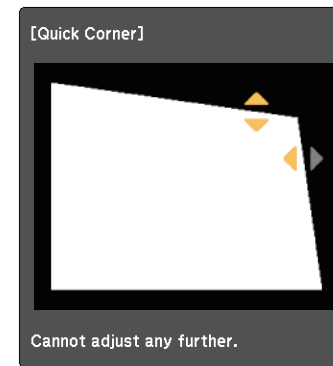

[Left Arrow / Right Arrow]:Adjust
 [Esc] / [Right Arrow]:Return

- 6** Repeat procedures 4 and 5 as needed to adjust any remaining corners.
- 7** When you are done, press the [Esc] button to exit the correction menu.

Because **Keystone** was changed to **Quick Corner**, the corner selection screen shown in step 4 is displayed the next time you press the [Z] or [V] button on the control panel. Change **Keystone** to **H/V-Keystone** if you want to perform horizontal and vertical correction using the [Z] or [V] button on the control panel.



If the [Esc] button is held down for about two seconds while the corner selection screen from step 4 is displayed, the following screen is displayed.

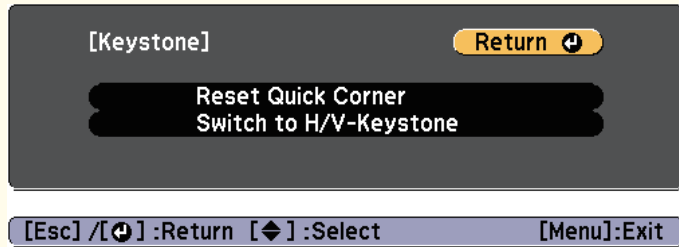

Reset Quick Corner: Resets the result of Quick Corner corrections.
Switch to H/V-Keystone: Switches the correction method to H/V-Keystone.
 📖 "Settings Menu" p.88

Adjusting the Image Position

Press the foot adjust lever to extend the front adjustable foot. You can adjust the position of the image by tilting the projector up to 12 degrees.

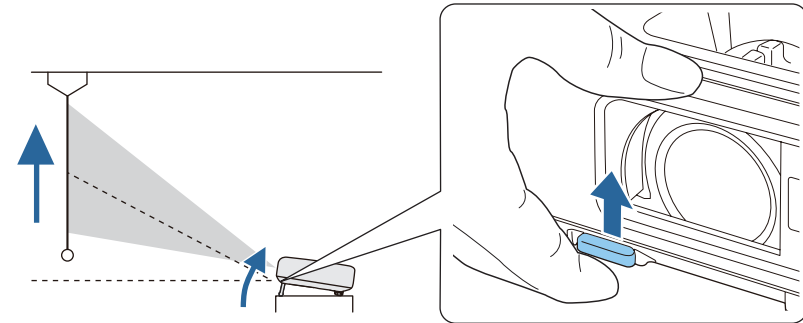

The larger the angle of tilt, the harder it becomes to focus. Install the projector so that it only needs to be tilted at a small angle.

Adjusting the Image Size

Turn the zoom ring to adjust the size of the projected image.

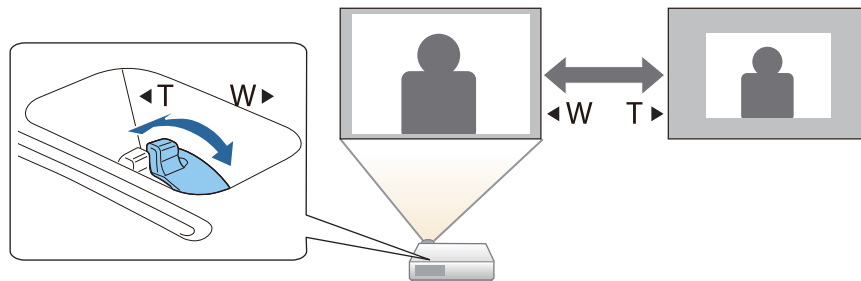

Adjusting the Horizontal Tilt

Extend and retract the rear feet to adjust the projector's horizontal tilt.

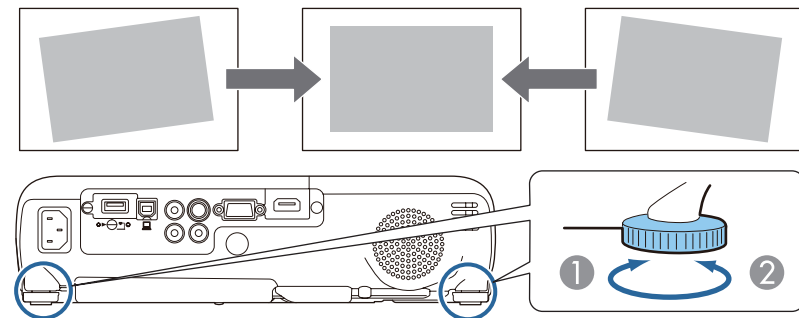

- ① Extend the rear foot.
- ② Retract the rear foot.

Correcting the Focus

You can correct the focus using the focus ring.

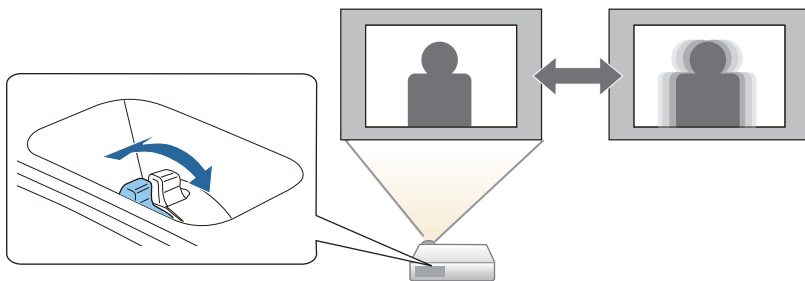

Adjusting the Volume

You can adjust the volume using one of the following methods.

- Press the [Volume] button on the control panel or the remote control to adjust the volume.
 - [🔊] Decreases the volume.
 - [🔊] Increases the volume.

Using the remote control

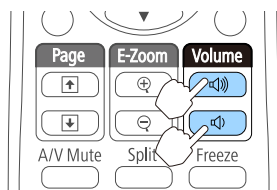

Using the control panel

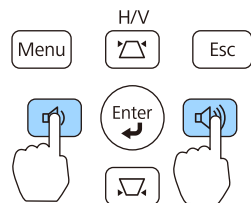

- Adjust the volume from the Configuration menu.
 - ☛ Settings - Volume [p.88](#)

Caution

Do not start at high volume. A sudden excessive volume may cause loss of hearing. Always lower the volume before powering off, so that you can power on and then gradually increase the volume.

Selecting the Projection Quality (Selecting Color Mode)

Sets the Color Mode according to the surroundings. The brightness of the image varies depending on the mode selected.

When a 2D signal is being input

Mode	Application
Dynamic	Ideal for use in a bright room.
Living Room	Ideal for use in a room when the curtains are closed.
Cinema	Ideal for watching films in a dark room. Gives images a natural tone.
Game	<ul style="list-style-type: none"> • Ideal for playing games in a bright room. • It takes a few seconds to switch to Game mode.

When a 3D signal is being input

Mode	Application
3D Dynamic	Ideal for use in a bright room. This is the brightest mode, and reproduces shadow tones well.
3D Cinema	Ideal for watching films in a dark room. Gives images a natural tone.

Each time you press the [Color Mode] button, the Color Mode name is displayed on the screen and the Color Mode changes.

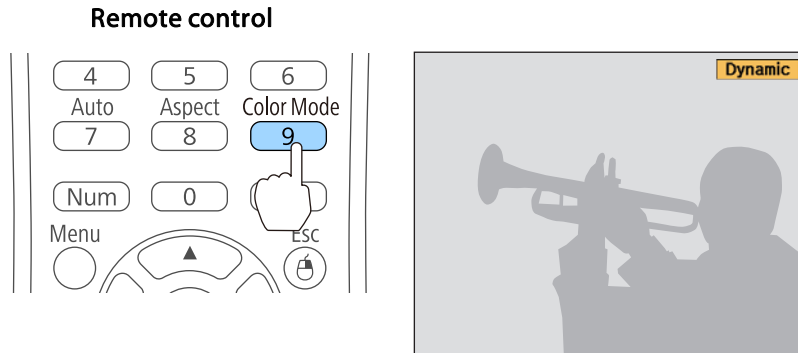

You can set Color Mode from the Configuration menu.
 Image - Color Mode [p.85](#)

Setting Auto Iris

By automatically setting the luminance according to the brightness of the displayed image, it lets you enjoy deep and rich images.

- 1 Press the [Menu] button.
 "Using the Configuration Menu" [p.82](#)

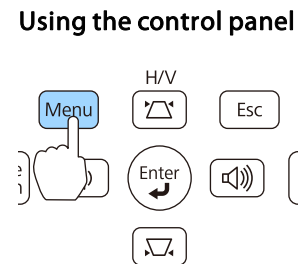
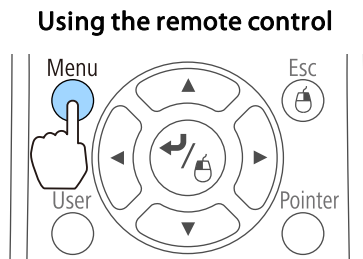

- 2 Select **Auto Iris** from **Image**.

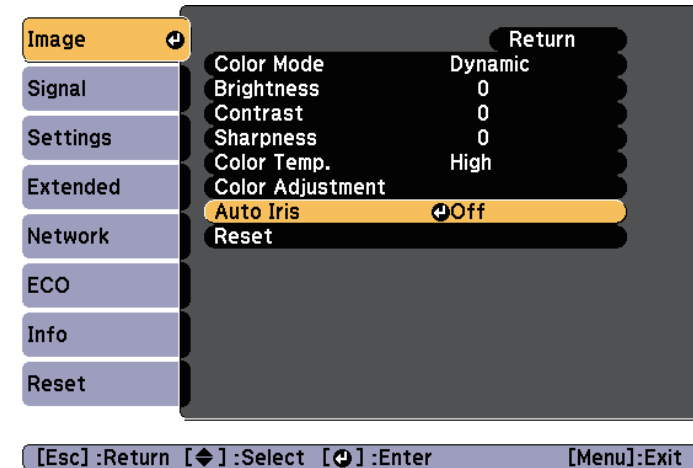

- 3 Select **Normal** or **High Speed**.
 The setting is stored for each Color Mode.

When set to **High Speed**, the brightness of the image is adjusted as soon as the scene changes.

- 4 Press the [Menu] button to finish making settings.

Changing the Aspect Ratio of the Projected Image

You can change the Aspect Ratio of the projected image to suit the type, the ratio of height and width, and the resolution of the input signals.

Available aspect modes vary depending on the image signal currently being projected.

Changing methods

Each time you press the [Aspect] button on the remote control, the aspect mode name is displayed on the screen and the aspect ratio changes.

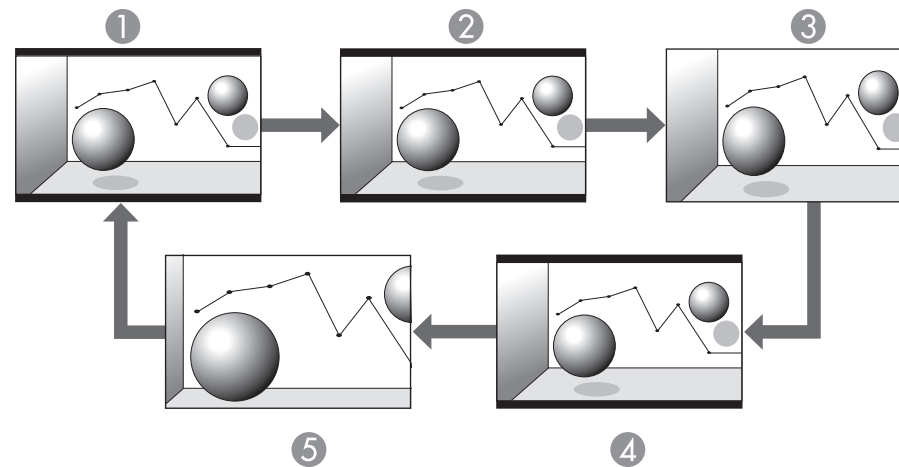
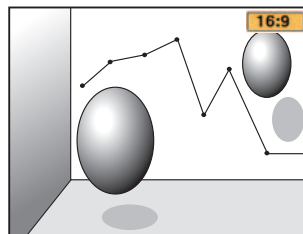
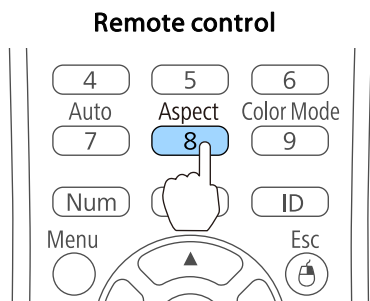

- ① Normal or Auto
- ② 16:9
- ③ Full
- ④ Zoom
- ⑤ Native

- You can set the aspect ratio from the Configuration menu.
- **Signal - Aspect p.85**
- In 3D mode, the aspect mode is set to **Normal**.

Changing the aspect mode

Projecting images from video equipment or from the HDMI/MHL port

Each time the [Aspect] button is pressed, the aspect mode changes in the order **Normal or Auto**, **16:9**, **Full**, **Zoom**, and **Native**.

Example: 1080p signal input (resolution: 1920x1080, aspect ratio: 16:9)

Projecting images from a computer

The following shows projection examples for each aspect mode.

Aspect Mode	Input Signal	
	XGA 1024X768(4:3)	WXGA 1280X800(16:10)
Normal		

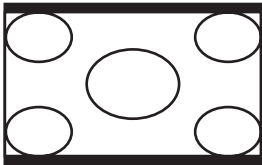
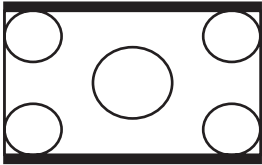
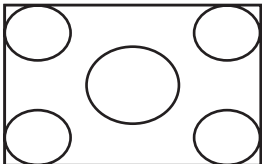
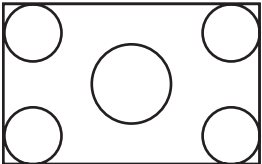
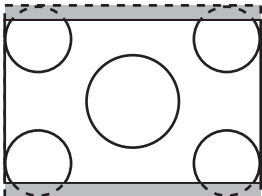
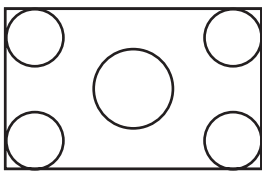
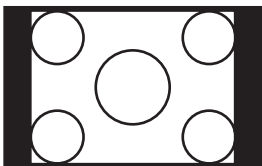
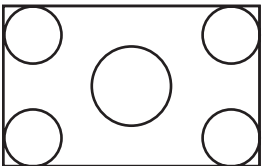
Aspect Mode	Input Signal	
	XGA 1024X768(4:3)	WXGA 1280X800(16:10)
16:9		
Full		
Zoom		
Native		



If parts of the image are missing, set the **Resolution** setting to **Wide** or **Normal** from the Configuration menu, according to the size of the computer panel.

☛ **Signal - Resolution** [p.85](#)



Useful Functions

This chapter explains useful tips for giving presentations, and the Security functions.

Projecting Two Images Simultaneously (Split Screen)

You can simultaneously project images from two sources on the right and left of the screen.

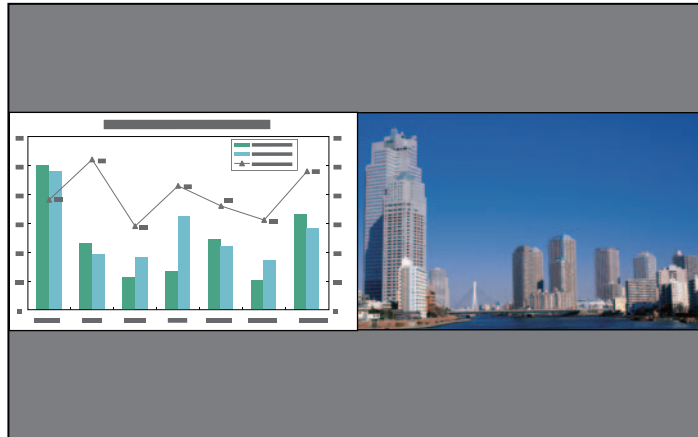

Input sources for split screen projection

The combinations of input sources that can be projected on a split screen are listed below.

Left Screen	Right Screen						
	Com-puter	S-Vid-eo	Video	HDMI	USB Dis-play	USB	LAN
Computer	-	-	-	✓	✓	✓	✓
S-Video	-	-	-	✓	✓	✓	✓
Video	-	-	-	✓	✓	✓	✓
HDMI	✓	✓	✓	-	✓	✓	✓

Left Screen	Right Screen						
	Com-puter	S-Vid-eo	Video	HDMI	USB Dis-play	USB	LAN
USB Dis-play	✓	✓	✓	✓	-	-	-
USB	✓	✓	✓	✓	-	-	-
LAN	✓	✓	✓	✓	-	-	-

Operating procedures

Projecting on a split screen

- 1 Press the [Split] button while projecting.
The currently selected input source is projected on the left of the screen.

Remote control

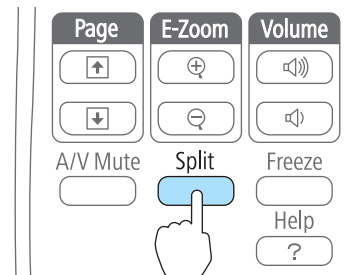

You can perform the same operations from the Configuration menu.

☛ **Settings - Split Screen** p.88

- 2** Press the [Menu] button.
The Split Screen Setup screen is displayed.

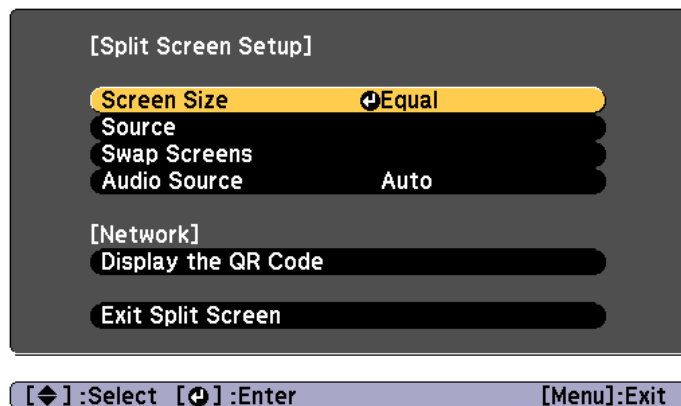

- 3** Select **Source**, and then press the [↵] button.

- 4** Select each input source for **Left** and **Right**.

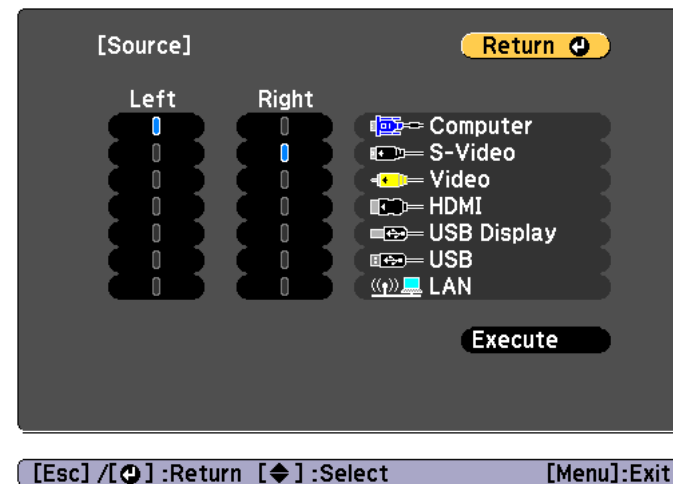

Only input sources that can be combined can be selected.

☞ "Input sources for split screen projection" [p.48](#)



The Source screen is also displayed when the following buttons are pressed during split screen projection.

- [Source Search] button
- [Computer] button
- [Video] button
- [USB] button
- [LAN] button

- 5** Select **Execute**, and then press the [↵] button.

To switch the source during split screen projection, start the procedure from step 2.

Switching the left and right screens

Use the following procedure to switch the projected images displayed on the left and right screens.

- 1** Press the [Menu] button during split screen projection.
- 2** Select Swap Screens, and then press the [↵] button.
The projected images on the left and right are swapped.



Switching the left and right image sizes

- 1** Press the [Menu] button during split screen projection.
- 2** Select the **Screen Size**, and then press the [↵] button.
- 3** Select the screen size you want to display, and then press the [↵] button.

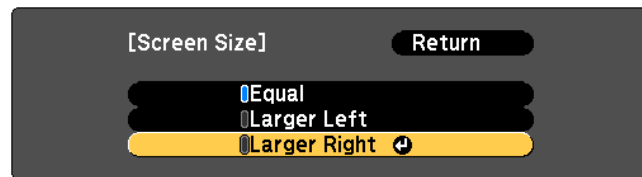

The projected images will appear as shown below after setting the screen size.

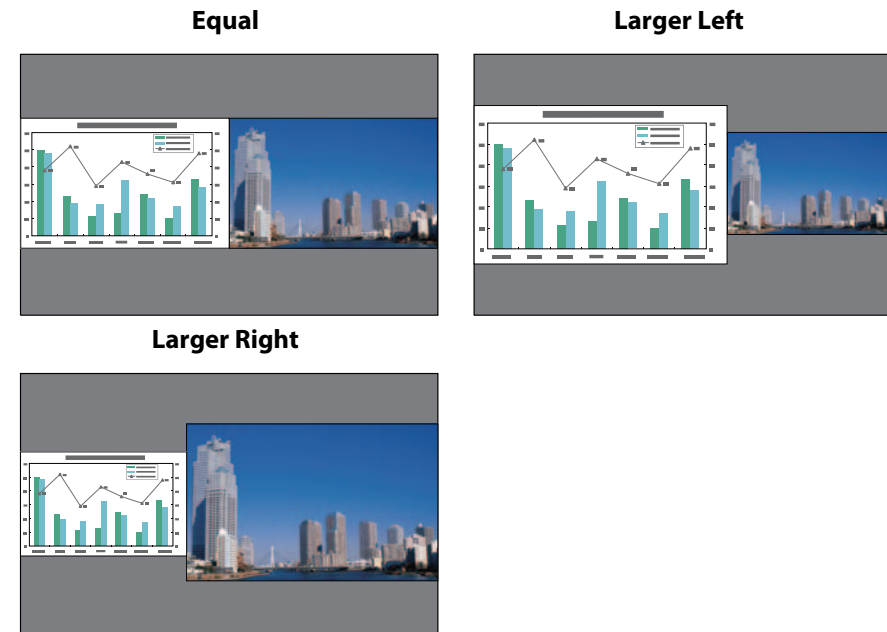

- You cannot enlarge both the left screen and right screen images at the same time.
- When one image is enlarged, the other image is reduced.
- Depending on the video signals that are input, the images on the left and right may not appear to be the same size even if **Equal** is set.

Ending the split screen

To end split screen, press the [Esc] button.

The following steps can also be used to end the split screen.

- Press the [Split] button on the remote control.

- Select **Exit Split Screen** from the Configuration menu.
 - ☛ **Settings - Split Screen - Split Screen Setup** p.88

Restrictions during split screen projection

Operating restrictions

The following operations cannot be performed during split screen projection.

- Setting the Configuration menu
- E-Zoom
- Switching the aspect mode (**Normal** is used for the aspect mode.)
- Operations using the [User] button on the remote control
- Auto Iris
- 3D Display

Help can be displayed only when image signals are not input or when an error or warning notification is displayed.

Restriction relating to images

- The default values for the **Image** menu are applied to the image on the right screen. However, the settings for the image projected on the left screen are applied to the image on the right screen for **Color Mode**, **Color Temp.**, **Color Adjustment**, **Brightness**, **Contrast**, **Color Saturation**, and **Tint**.
- The setting value **Off** for **Progressive** and **Noise Reduction** is applied to the image on the right screen.
 - ☛ "Signal Menu" p.85
- When there is no image signal being input, the display screen is the color that is set in Display Background. When **Logo** is selected, the display is **Blue**.
- When A/V Mute is performed, the display is **Black**.

Projecting 3D Images

You can connect devices that support 3D playback, such as 3D Blu-ray discs and 3D games, and enjoy stunning 3D images.

Preparing to view 3D images

Make the following preparations before viewing 3D images.

- RF active 3D Glasses (optional/ELPGS03)
 - See the User's Guide for the 3D Glasses for more information on the 3D Glasses.
- USB Charging Adapter (optional/ELPAC01)
- HDMI cable that supports 3D signals (available in local stores)
- Make the following settings from the Configuration menu.
 - **3D Display: On**
 - **3D Format: Auto** or the same format as the 3D signal from the connected device
- ☛ **Signal - 3D Setup** p.85

Supported 3D signals

The projectors support the following 3D signals.

- Frame Packing
- Side by Side
- Top and Bottom

Charging the 3D Glasses

You need to charge the 3D Glasses before use.

Use the supplied charging cable to connect the 3D Glasses to the USB Charging Adapter, and then connect the USB Charging Adapter to an electrical outlet.

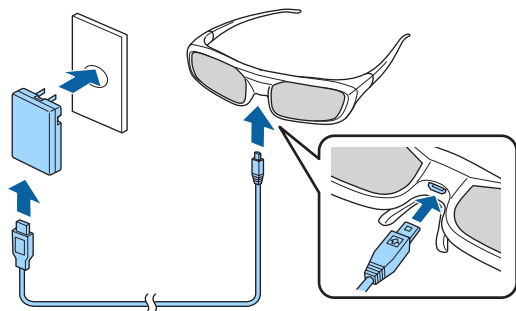

Connect the charging cable to the projector's USB-A port to charge the 3D Glasses. (Only when the projector is on.)

Attention

- Only connect to an electrical outlet that uses the voltage displayed on the adapter.
- Note the following points when handling the charging cable supplied with the 3D Glasses.
 - Do not use the cable if it is damaged.
 - Do not modify the cable.
 - Do not bend, twist, or pull the cable with too much force.
 - Do not position it near an electric heater.



The following shows the standard charging and usage times.

- For a 3 minute charge, the usage time is approximately 3 hours.
- For a 50 minute charge, the usage time is approximately 40 hours.

Registering the 3D Glasses to the projector (pairing)

When viewing 3D images, the projector communicates with the 3D Glasses. To communicate correctly, the 3D Glasses have to be registered to the projector. This is known as "pairing".

Perform pairing in the following situations.

- When turning on the 3D Glasses for the first time. Pairing starts automatically when the power is turned on.
- When you cannot view 3D images correctly. Follow the steps below to perform pairing.

- 1** Turn on the projector.
- 2** Press the [Source Search] button on the control panel or the remote control, and then select **HDMI**.
- 3** Turn on the 3D Glasses by sliding the power switch to [On]. The indicator turns on for several seconds, and then turns off.

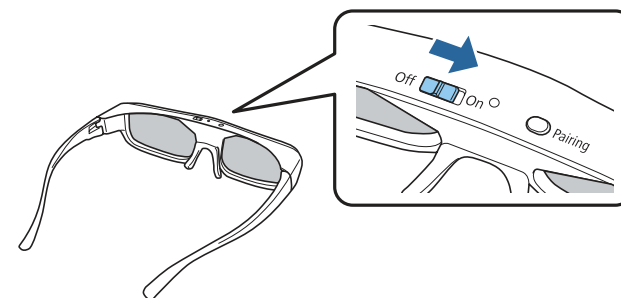

- 4 Hold down the [Pairing] button on the 3D Glasses for three seconds.

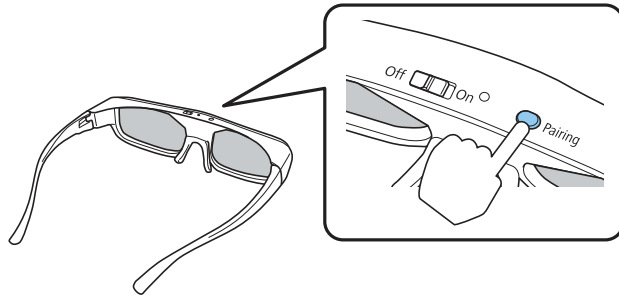

The indicator flashes alternately green and red. If pairing is successful, the indicator turns green for ten seconds and then turns off.



- If pairing is not successful, the 3D Glasses turn off.
- When performing pairing, make sure the distance between the projector and the 3D Glasses is less than three meters.
- You can pair up to 50 3D Glasses with this projector.

Viewing 3D images

- 1 Connect the projector to the playback device with an HDMI cable.



3D images can only be viewed when HDMI is being input. Prepare an HDMI cable that supports 3D signals.

See the following for more information on connecting the HDMI cables.

- ☛ "Connecting Equipment" [p.23](#)

- 2 Turn on the playback device and the projector, and then project the image.

If the image is not projected, press the [Source Search] button on the control panel or the remote control, and then select **HDMI**.

- 3 Turn on and wear the 3D Glasses.
Perform pairing when using the 3D Glasses for the first time.

- ☛ "Registering the 3D Glasses to the projector (pairing)" [p.52](#)



- How a 3D image is perceived varies depending on the individual.
- If you cannot view the 3D effect correctly, perform **Inverse 3D Glasses** from the Configuration menu.
 - ☛ **Signal - 3D Setup - Inverse 3D Glasses** [p.85](#)
- How the 3D image is viewed may change depending on the temperature around the projector and how long the lamp has been used. Refrain from using the projector if the image is not projected normally.
- After viewing, slide the [Power] switch on the 3D Glasses to Off.
- If the 3D Glasses do not receive a 3D signal for at least 30 seconds, they turn off automatically. To turn the 3D Glasses back on, slide the [Power] switch to Off, and then slide it back to On.
- The following functions are unavailable while viewing 3D images.
 - Capturing a User's Logo
 - Pointer
 - E-Zoom
- If you perform the following functions while viewing a 3D image, the image becomes 2D.
 - Displaying the Test Pattern
 - A/V Mute
 - Freeze

Converting 2D images to 3D images

Convert 2D images from the HDMI/MHL port to 3D images.

1 Press the [Menu] button.

☞ "Using the Configuration Menu" p.82

Using the remote control

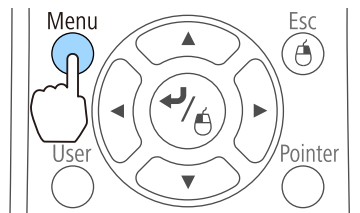

Using the control panel

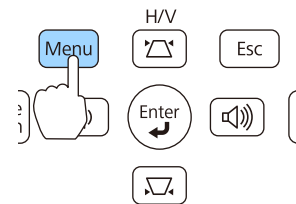

2 Select **3D Setup** from **Signal**.

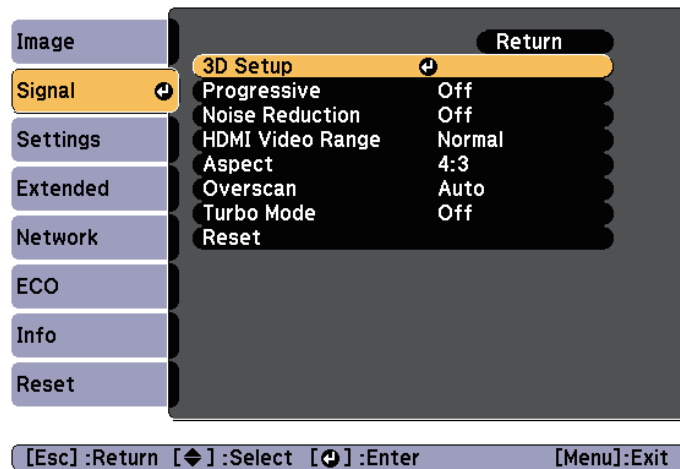

3 Select **2D-to-3D Conversion**, and then select the strength of the 3D effect.

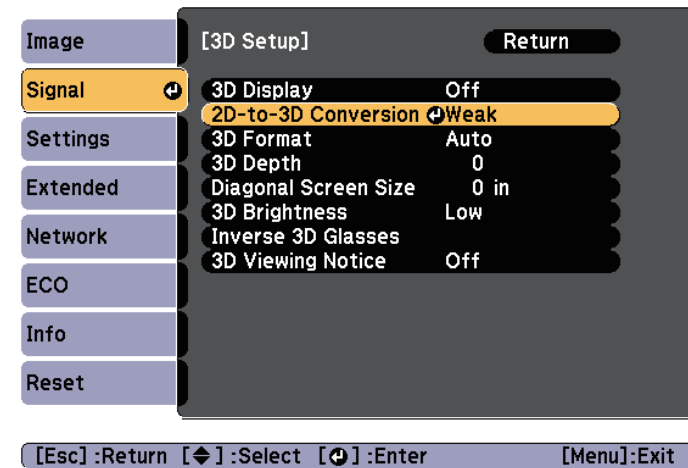

You can select the strength of the 3D effect from the following three options; **Weak**, **Medium**, or **Strong**.



When using **2D-to-3D Conversion**, set **3D Format** to **Auto** or **2D**.

☞ **Signal - 3D Setup - 3D Format** p.85

Viewing area for 3D images

The following indicates the viewing area for 3D images. View within an area of 10 meters from the projector.

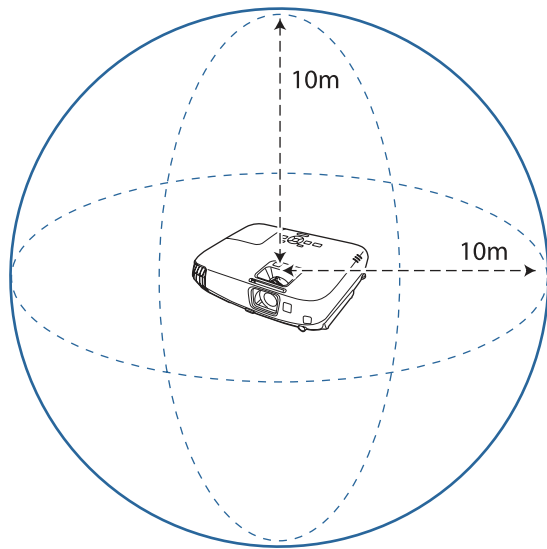

- You may not be able to view 3D images correctly if there is any interference from other Bluetooth communication devices.
- The 3D Glasses use the same frequency (2.4 GHz) as wireless LAN (IEEE802.11b/g) or microwave ovens to communicate. If these devices are used at the same time, radio wave interference may occur and the image may be interrupted. If you do need to use these devices at the same time, make sure there is enough distance between them and the projector.
- The 3D Glasses for this projector use the active shutter system based on the standards provided by the Full HD 3D Glasses Initiative.

Warning

- Do not disassemble or remodel the 3D Glasses.
This could cause a fire to occur or the images to appear abnormal when viewing, causing you to feel unwell.
- Do not leave the 3D Glasses or the supplied parts within reach of children. They could be accidentally swallowed. If anything is accidentally swallowed, contact a doctor immediately.
- Do not place the 3D Glasses in a fire, on a heat source, or leave them unattended in a location subject to high temperatures. Because this device has a built-in rechargeable lithium battery, it could cause burns or a fire if it becomes hot or explodes.
- When charging, connect the supplied cable to the USB port designated by Epson. Do not charge using other devices as it may cause the battery to leak, overheat, or explode.
- Only use the supplied charging cable to charge the 3D Glasses. Otherwise, it could overheat, ignite, or explode.

Wireless (Bluetooth) communication

- Electromagnetic interference may cause medical equipment to malfunction. Before using the device, make sure there is no medical equipment in the vicinity.
- Electromagnetic interference may cause automatically controlled equipment to malfunction which could cause an accident. Do not use the device near automatically controlled equipment such as automatic doors or fire alarms.

Warnings regarding viewing 3D images

Note the following important points when viewing 3D images.

Cautions regarding using 3D Glasses

Caution

- Do not drop or press too forcefully on the 3D Glasses.
If the glass sections and so on are broken, an injury could occur. Store the glasses in the soft glasses case supplied.
- Be careful of the edges of the frame when wearing the 3D Glasses.
If they poke your eye and so on, an injury could occur.
- Do not place your finger in any of the moving sections (such as the hinges) of the 3D Glasses.
Otherwise an injury could occur.
- When disposing of the 3D Glasses, follow your local rules and regulations.
- Make sure you wear the 3D Glasses correctly.
Do not wear the 3D Glasses upside down.
If the image is not displayed correctly, it could cause you to feel unwell.
- Do not wear the glasses unless you are viewing a 3D image.
- How a 3D image is perceived varies depending on the individual. Stop using the 3D function if you feel strange or cannot see in 3D. Continuing to view the 3D images could cause you to feel unwell.
- Stop wearing the 3D Glasses immediately if they seem abnormal or a malfunction occurs. Continuing to view the 3D images could cause you harm and to feel unwell.
- Stop wearing the 3D Glasses if your ears, nose, or temples become red, painful, or itchy. Continuing to view the 3D images could cause you to feel unwell.
- Stop wearing the 3D Glasses if your skin feels unusual when wearing the glasses. The paint or materials used in the 3D Glasses could cause an allergic reaction.

Cautions when viewing images

Caution

When viewing 3D images, always take periodic breaks during extended viewing. Long periods of viewing 3D images may cause eye fatigue.

The necessity and timing of breaks varies from person to person. If your eyes still feel tired or uncomfortable even after taking a break from viewing, stop viewing immediately.

Cautions regarding viewing methods

Caution

- If your eyes feel fatigued or uncomfortable when viewing 3D images, stop viewing immediately. Continuing to view the 3D images could cause you to feel unwell.
- When viewing 3D images be sure to always wear 3D Glasses. Do not attempt to view 3D images without 3D Glasses. Doing so could cause you to feel unwell.
- Do not place any breakable or fragile objects around you when using 3D Glasses. 3D images may cause you to move your body involuntarily, resulting in damage to nearby items or personal injury.
- Only wear 3D Glasses when viewing 3D images. Do not move around while wearing 3D Glasses. Your vision may appear darker than normal, causing you to fall or injure yourself.
- View from in front of the screen.
Viewing 3D images at an angle reduces the 3D effect and may cause you to feel unwell due to unintended color changes.
- If using 3D Glasses in a room with fluorescent or LED lighting, you may see flashing or flickering throughout the room. If this should occur, reduce the lighting until the flickering goes away or turn off the lights completely when viewing 3D images. This flickering could trigger seizures or fainting for some individuals. If you begin to feel uncomfortable or unwell at any time when viewing 3D images, stop immediately.
- Stay at least three times the height of the screen away from the screen when viewing 3D images.

The recommended viewing distance for an 80-inch screen is at least 3 meters, and at least 3.6 meters for a 100-inch screen. Sitting or standing any closer than the recommended viewing distance may result in eye fatigue.

- When viewing 3D images, we recommend using a screen size smaller than 120 inches.

If the screen size is too large, you may experience eyestrain or nausea due to the content, viewing environment, your physical condition, and so on.

Cautions for the viewer

Caution

You should not use 3D Glasses if you are sensitive to light, have a heart condition, or are unwell. Doing so could aggravate your pre-existing conditions.

Cautions regarding the viewing age (for children)

Caution

- The minimum recommended age to view 3D images is six years old.
- Children under the age of six are still developing and viewing 3D images may cause complications. Consult your doctor if you have any concerns.
- Children viewing 3D images through 3D Glasses should always be accompanied by an adult.
It is often difficult to tell when a child is feeling tired or uncomfortable, which could result in them feeling suddenly unwell. Always check that children in your care are not experiencing any eye fatigue during viewing.

Projecting Without a Computer (PC Free)

By connecting a USB storage device such as a USB flash drive or a USB hard disk to the projector, you can project the files stored on the device without using a computer. This function is called PC Free.



- You may not be able to use USB storage devices that incorporate security functions.
- You cannot correct keystone distortion while projecting in PC Free, even if you press the [↖] and [↗] buttons on the control panel.

Specifications for files that can be projected using PC Free

Type	File Type (Ex-tension)	Notes
Image	.jpg	The following cannot be projected. - CMYK color mode formats - Progressive formats - Images with a resolution greater than 8192 x 8192 Due to the characteristics of JPEG files, images may not be projected clearly if the compression ratio is too high.
	.bmp	Cannot project images with a resolution greater than 1280x800.
	.gif	<ul style="list-style-type: none"> Cannot project images with a resolution greater than 1280x800. Cannot project animated GIFs.
	.png	Cannot project images with a resolution greater than 1280x800.
Movie	.avi (Motion JPEG)	<ul style="list-style-type: none"> Cannot project images with a resolution greater than 1280x720. The audio format can only playback linear PCM and ADPCM. Supports AVI 1.0. You cannot project files over 2 GB.



- When connecting and using a USB-compatible hard disk, make sure you connect the AC adaptor supplied with the hard disk.
- The projector does not support some file systems, so use media that has been formatted in Windows.
- Format the media in FAT16/32.

PC Free examples

Projecting images stored on USB storage



- "Projecting the selected images or movies" [p.61](#)
- "Projecting image files in a folder in sequence (Slideshow)" [p.61](#)





PC Free operating methods

Although the following steps are explained based on the remote control, you can perform the same operations from the control panel.

Starting PC Free

- Change the source to USB.
 - "Switching to the Target Image by Remote Control" [p.34](#)
- Connect the USB storage device to the projector.
 - "Connecting USB Devices" [p.27](#)
 PC Free starts and the file list screen is displayed.

- The following files are displayed as thumbnails (file contents are displayed as small images).
 - JPEG files
 - AVI files (displays the image at the start of the movie)
- Other files or folders are displayed as icons as shown in the following table.

Icon	File	Icon	File
	JPEG files*		BMP files
	GIF files		PNG files
	AVI (Motion JPEG) files*		

* When it cannot be displayed as a thumbnail, it is displayed as an icon.





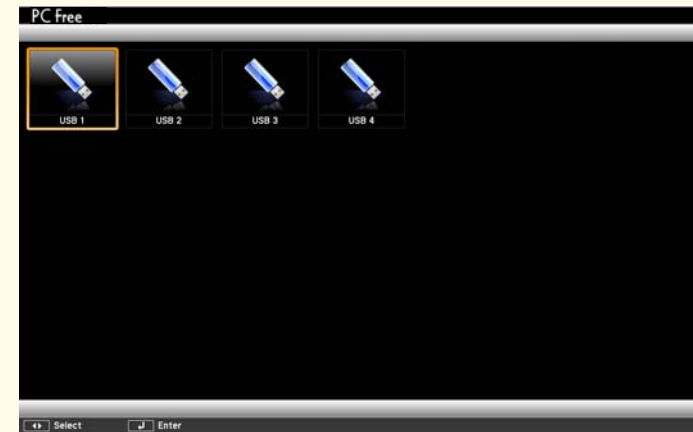

- You can also insert a memory card into a USB card reader and then connect the reader to the projector. However, some commercially available USB card readers may not be compatible with the projector.
- If the following screen (Select Drive screen) is displayed, press the [←], [→], [⏪], or [⏩] buttons to select the drive you want to use, and then press the [↵] button.







- To display the Select Drive screen, position the cursor on **Select Drive** at the top of the file list screen, and then press the [↵] button.



Projecting images

- 1 Press the , , , or  buttons to select the file or folder you want to project.





If not all of the files and folders are displayed on the current screen, press the  button on the remote control, or position the cursor on **Next Page** at the bottom of the screen and press the  button.

To return to the previous screen, press the  button on the remote control, or position the cursor on **Previous Page** at the top of the screen and press the  button.

- 2 Press the  button.
The selected image is displayed.
When a folder is selected, the files in the selected folder are displayed. To return to the previous screen, position the cursor on **Back to Top** and press the  button.

Rotating images

You can rotate the played images in 90° increments. The rotating function is also available during Slideshow.

- 1 Play images, or run Slideshow.
- 2 While projecting, press the  or  button.

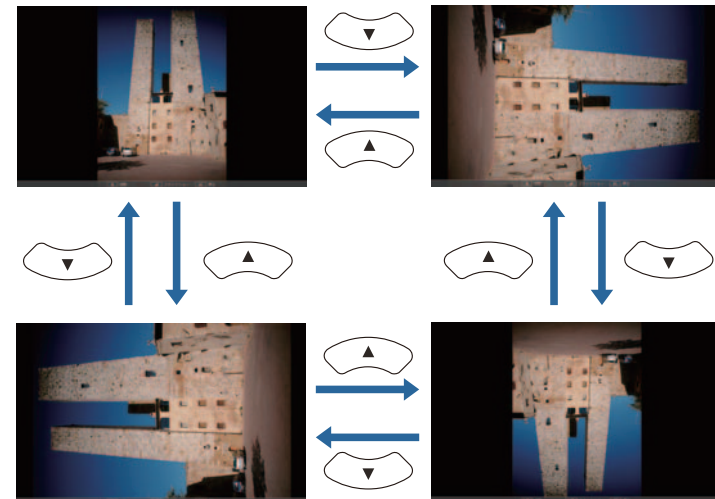





Stopping PC Free

To close PC Free, disconnect the USB device from the USB port on the projector. For devices such as digital cameras or hard disks, turn off the device and then remove it from the projector.

Projecting the selected images or movies

Attention



Do not disconnect the USB storage device while it is being accessed. PC Free may not operate correctly.

- 1 Start PC Free.
The file list screen is displayed.
☛ "Starting PC Free" [p.58](#)
- 2 Use the , , , and  buttons to select the image file you want to project.



- 3 Press the  button.
The image is displayed or the movie is played back.



Press the ,  buttons to move to the next or previous image file.

- 4 To finish projecting, perform one of the following operations.
 - Projecting an image: Press the [Esc] button.
 - Projecting a movie: Press the [Esc] button to display the message screen, select **Exit**, and then press the  button.

When projection is finished, you are returned to the file list screen.

Projecting image files in a folder in sequence (Slideshow)

You can project the image files in a folder in sequence, one at a time. This function is called Slideshow. Use the following procedure to run Slideshow.



To change files automatically when you run Slideshow, set **Screen Switching Time** from **Option** to anything other than **No**. The default setting is 3 seconds.

☛ "Image file display settings and Slideshow operation settings" [p.62](#)

- 1 Start PC Free.
The file list screen is displayed.
☛ "Starting PC Free" [p.58](#)

2 Press the [⏪], [⏩], [⏴], or [⏵] buttons to position the cursor over the folder for the Slideshow that you want to run, and then press the [↵] button.

3 Select **Slideshow** at the bottom right of the file list screen, and then press the [↵] button.

Slideshow starts, and the image files in the folder are automatically projected in sequence, one at a time.

When the last file is projected, the file list is displayed again automatically. If you set **Continuous Play** to **On** in the Option window, projection starts again from the beginning when it reaches the end.

☛ "Image file display settings and Slideshow operation settings" p.62

You can proceed to the next screen, return to the previous screen, or stop playback while projecting a Slideshow.

 If **Screen Switching Time** on the Option screen is set to **No**, files do not change automatically when you select Play Slideshow. Press the [⏴] button, the [↵] button, or the [⏵] button to continue to the next file.

You can use the following functions when projecting a file with PC Free.

- Freeze
 - ☛ "Freezing the Image (Freeze)" p.66
- A/V Mute
 - ☛ "Hiding the Image and Sound Temporarily (A/V Mute)" p.65
- E-Zoom
 - ☛ "Enlarging Part of the Image (E-Zoom)" p.67

- Pointer
 - ☛ "Pointer Function (Pointer)" p.66

Image file display settings and Slideshow operation settings

You can set the file display order and Slideshow operations on the Option screen.

1 Select **Option** at the bottom of the file list screen, and then press the [↵] button.

2 When the following Option screen is displayed, set each of the items.

Select any of the options as necessary and press the [↵] button.

The following table shows the details for each item.

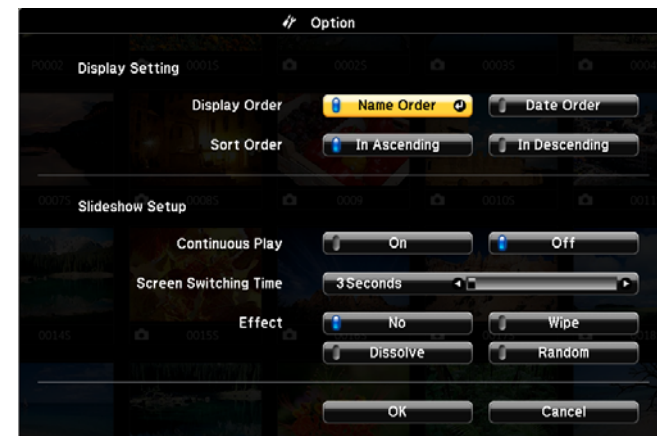

Display Order	You can select to display the files in Name Order or Date Order .
Sort Order	You can select to sort the files In Ascending or In Descending order.

Continuous Play	You can set whether to repeat the Slideshow.
Screen Switching Time	You can set the time for a single file to be displayed in Slideshow. You can set a time between No (0) to 60 Seconds. When you set No , auto play is disabled.
Effect	You can set the screen effects when changing slides.

3 When you have finished making settings, use the [◀], [▶], [⏪], or [⏩] buttons to position the cursor over **OK**, and then press the [↵] button.

The settings are applied.

If you do not want to apply the settings, position the cursor on **Cancel**, and then press the [↵] button.

Projecting Using a QR Code

By reading a QR code displayed on the projected screen with Epson iProjection (V1.3.0 or later), you can easily project data on a smartphone or tablet device.

Check the following points before starting projection using a QR code.

- The supplied or optional wireless LAN unit is installed on the projector
- **Wireless Power** is set to **Wireless LAN On** from the Configuration menu



You can download Epson iProjection for free from the App Store or from Google play. Any fees incurred when communicating with the App Store or Google play are the responsibility of the customer.

Setting the display method for QR codes

Set the QR code display from the Configuration menu.

1 Press the [Menu] button.

☛ "Using the Configuration Menu" p.82

Using the remote control

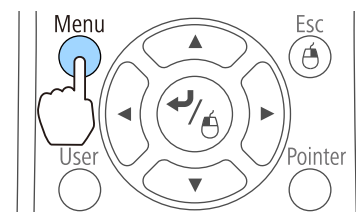

Using the control panel

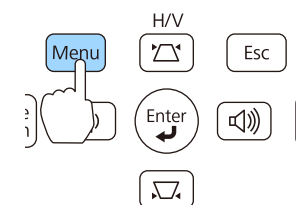

2 Select **Network Configuration** from **Network**.

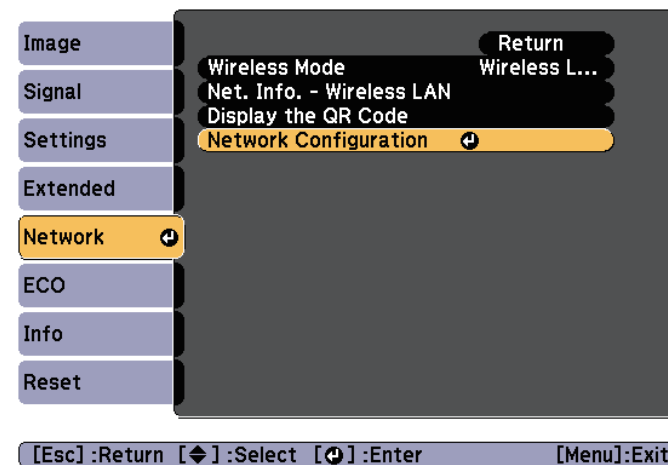

3 Select **Display LAN Info.** from **Basic**.

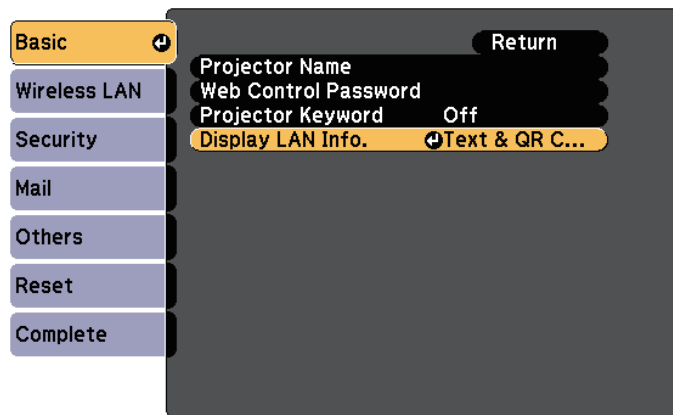

[Esc]:Return [◀]:Select [▶]:Enter

4 Select **Text & QR Code**.

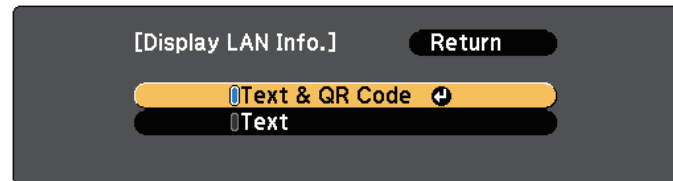

[Esc]:Return [◀]:Select [▶]:Set

Text & QR Code



Projecting data from a smartphone or tablet device

Project data from your device using Epson iProjection.

- 1 Start Epson iProjection on your smartphone or tablet device.
- 2 Tap **Projector** on the application screen.
The projector's search screen is displayed.
- 3 Tap **Read QR code** on the application screen.
The camera starts and the preview screen is displayed.
- 4 Press the [LAN] button on the remote control, or select **Display the QR Code** from the **Network** menu to display the QR code.

Remote control

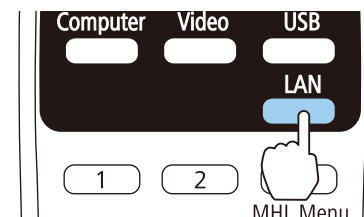

- When the projector is already receiving an image signal over the network, the QR code is not displayed even if you press the [LAN] button. Press the [Enter] button on the remote control or the control panel (only when the source is LAN), or select **Display the QR Code** from the **Network** menu to display the QR code.
- To hide the QR code, press the [Esc] button on the remote control or the control panel.

5 Read the projected QR code with your smartphone or tablet device.

Make sure you read the QR code from in front of the screen so that it fits into the guide. If you are too far from the screen, the code may not be read.

When the connection is established, the image from the connected device is displayed. Tap **Files** on the application screen, and then select the file you want to project.

Each time you press the [A/V Mute] button or open/close the lens cover, A/V Mute turns on or off.

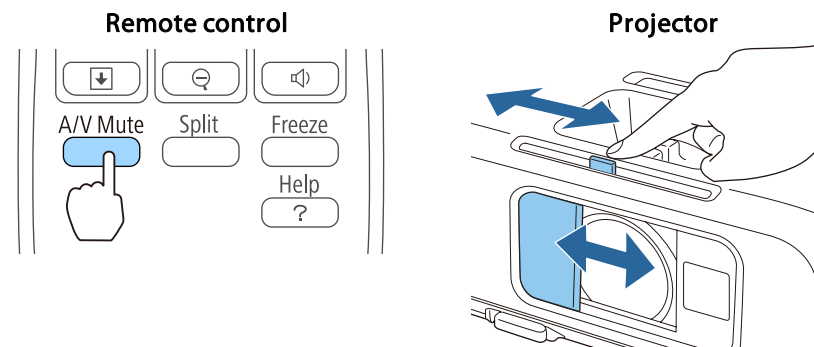

Hiding the Image and Sound Temporarily (A/V Mute)

You can use this when you want to hide the image on the screen, or if you do not want to show details such as when you are changing between files.

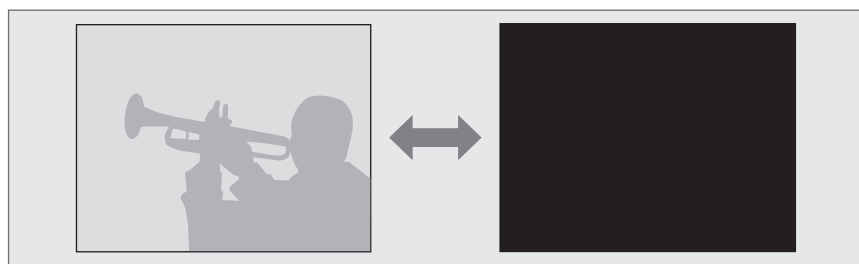

- When projecting moving images, the images and sound continue to be played back while A/V Mute is on. It is not possible to resume projection from the point where A/V Mute was activated.
- You can select the screen displayed when the [A/V Mute] button is pressed from the Configuration menu.
 - ☛ **Extended - Display - A/V Mute** p.89
- When A/V mute is enabled with the [A/V Mute] button, **A/V Mute Timer** activates and the power is automatically turned off after approximately 30 minutes. If you do not want to enable **A/V Mute Timer**, set **A/V Mute Timer** to **Off**.
 - ☛ **ECO - A/V Mute Timer** p.97
- When the A/V mute slide is closed for approximately 30 minutes, **Lens Cover Timer** activates and the power is automatically turned off. If you do not want **Lens Cover Timer** to activate, set **Lens Cover Timer** to **Off**.
 - ☛ **ECO - Lens Cover Timer** p.97
- The lamp is still lit during A/V Mute, so the lamp hours continue to accumulate.

Freezing the Image (Freeze)

When Freeze is activated on moving images, the frozen image continues to project on the screen, so you can project a moving image one frame at a time like a still photo. Also, you can perform operations such as changing between files during presentations from a computer without projecting any images if the Freeze function is activated beforehand.

Each time you press the [Freeze] button, Freeze turns on or off.

Remote control

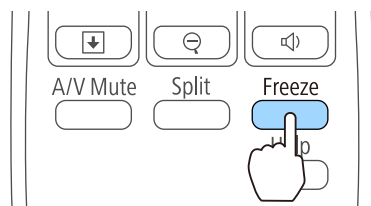

- Audio does not stop.
- When projecting moving images, the images continue to be played back while the screen is frozen. It is not possible to resume projection from the point where the screen was frozen.
- If the [Freeze] button is pressed while the Configuration menu or the Help screen is displayed, the menu or the Help screen that is displayed is closed.
- Freeze still works while E-Zoom is being used.

Pointer Function (Pointer)

This allows you to move a Pointer icon on the projected image, and helps you draw attention to the area you are talking about.

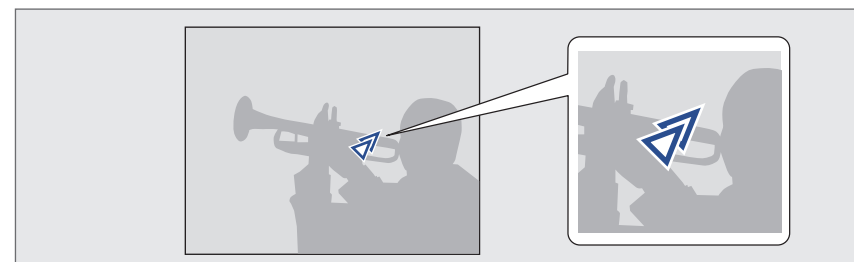

1 Display the Pointer.

Each time you press the [Pointer] button, the pointer appears or disappears.

Remote control

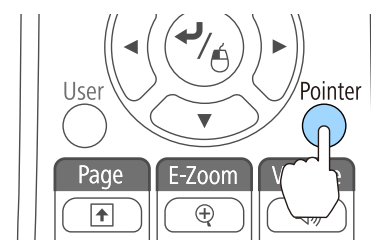

2 Move the Pointer icon (↗).

Remote control

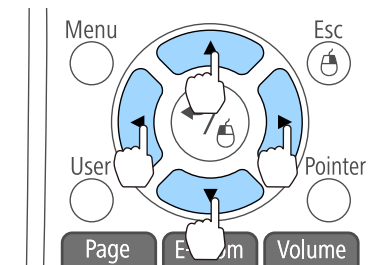

When any pair of adjacent [◀▶], [▶◀], [⏪⏩], or [⏩⏪] buttons are pressed at the same time, the pointer can be moved diagonally.



You can select the shape of the pointer icon from the Configuration menu.

Settings - Pointer Shape p.88

Enlarging Part of the Image (E-Zoom)

This is useful when you want to expand images to see them in greater detail.

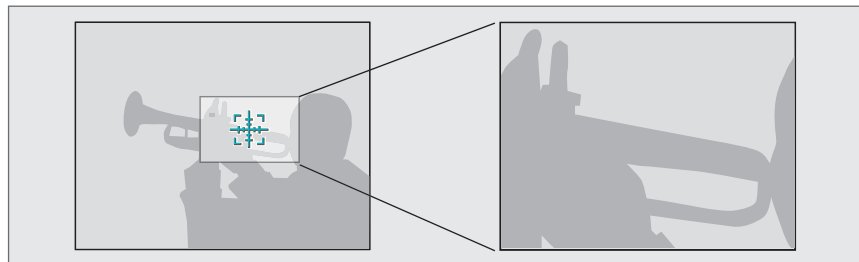

1 Start E-Zoom.

Press the [⊕] button to display the Cross (⊕).

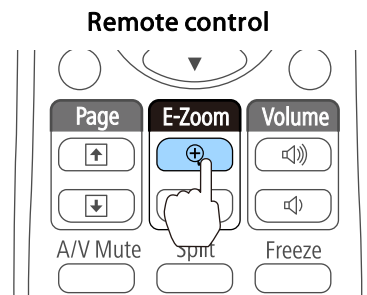

2 Move the Cross (⊕) to the area of the image that you want to enlarge.

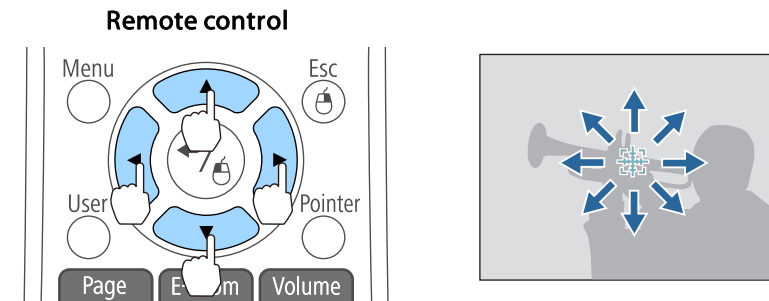

When any pair of adjacent [↖], [↘], [↙], or [↗] buttons are pressed at the same time, the pointer can be moved diagonally.

3 Enlarge.

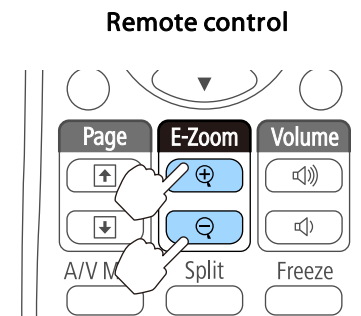

[⊕] button: Expands the area each time it is pressed. You can expand quickly by holding the button down.

[⊖] button: Reduces images that have been enlarged.

[Esc] button: Cancels E-Zoom.



- The enlargement ratio appears on the screen. The selected area can be enlarged to between 1 to 4 times in 25 incremental steps.
- During enlarged projection, press the [↖], [↘], [↙], or [↗] buttons to scroll the image.

Using the Remote Control to Operate the Mouse Pointer (Wireless Mouse)

You can control the computer's mouse pointer from the projector's remote control. This function is called Wireless Mouse.

The following operating systems are compatible with Wireless Mouse.

	Windows	OS X
OS	Windows 2000	Mac OS X 10.3.x
	Windows XP	Mac OS X 10.4.x
	Windows Vista	Mac OS X 10.5.x
	Windows 7	Mac OS X 10.6.x
	Windows 8	OS X 10.7.x
	Windows 8.1	OS X 10.8.x
		OS X 10.9.x

* It may not be possible to use the Wireless Mouse function under some versions of the operating systems.





Use the following procedure to enable the Wireless Mouse function.

- 1** Connect the projector to the computer with the USB cable.
 - ☛ "Connecting a Computer" [p.25](#)
- 2** Change the source to one of the following.
 - USB Display
 - Computer
 - HDMI
 - ☛ "Switching to the Target Image by Remote Control" [p.34](#)

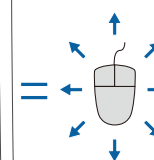
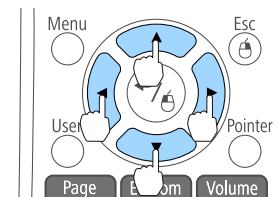
Once set, the mouse pointer can be controlled as follows.

Moving the mouse pointer



[][][][] buttons:
Moves the mouse pointer.



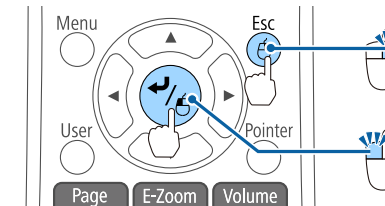



Mouse clicks

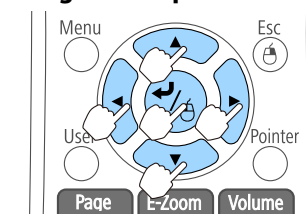

[Esc] button: Right click.
[] button: Left click. Press quickly twice to double-click.



Drag and drop

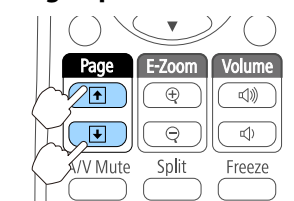

While holding down the [] button, press the [], [], [], or [] button.
Release the [] button to drop at the desired location.

Page Up/Down



[] button: Moves to the previous page.
[] button: Moves to the next page.



- When any pair of adjacent [↖], [↗], [↙], or [↘] buttons are pressed at the same time, the pointer can be moved diagonally.
- If the mouse button settings are set to reverse on the computer, the operation of the remote control buttons will also be reversed.
- The Wireless Mouse function does not work under the following conditions.
 - When projecting images from a device connected to the HDMI/MHL port using an MHL cable.
 - When the Configuration menu or a Help screen is displayed
 - When operating functions other than the Wireless Mouse function (such as adjusting the volume)
 However, when using the E-Zoom or Pointer function, the page up or down function is available.

Saving a User's Logo

You can save the image that is currently being projected as a User's Logo.



- Once a User's Logo has been saved, the logo cannot be returned to the factory default.
- If the content of the Configuration menu is set from another projector using the batch setup function, the registered User's Logo is set for the other projectors. Do not register confidential information and so on as the User's Logo.
 - ☛ "Performing Batch Setup for Multiple Projectors" p.100

- 1 Project the image you want to save as the User's Logo, and then press the [Menu] button.

☛ "Operating the Configuration Menu" p.82

Using the remote control

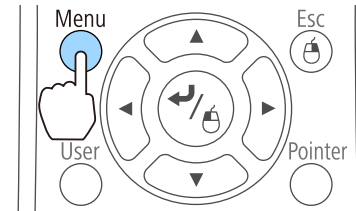

Using the control panel

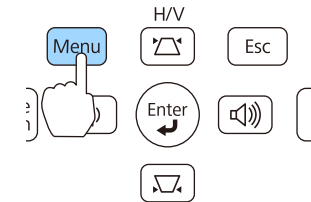

- 2 Select **User's Logo** from **Extended**.

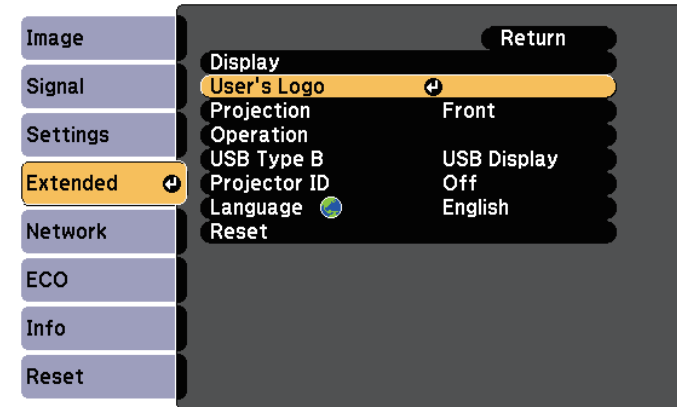

[Esc]:Return [↕]:Select [↵]:Enter [Menu]:Exit



- When **User's Logo Protection** from **Password Protection** is set to **On**, a message is displayed and the User's Logo cannot be changed. You can make changes after setting **User's Logo Protection** to **Off**.

☞ "Managing Users (Password Protect)" p.71

- If **User's Logo** is selected when Keystone, E-Zoom, Aspect, or Adjust Zoom are being performed, the function currently being performed is temporarily cancelled.

- 3** When the message "Choose this image as the User's Logo?" is displayed, select **Yes**.



When you press the [↵] button on the remote control or the control panel, the screen size may change depending on the signal to match the actual resolution of the image signal.

- 4** Move the box to select the part of the image to use as the User's Logo.

You can perform the same operations from the projector's control panel.

Remote control

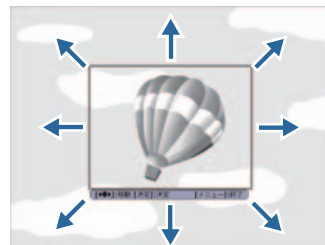
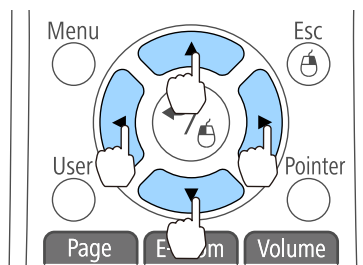

You can save at 400x300 dots in size.

- 5** When you press the [↵] button and the message "Select this image?" is displayed, select **Yes**.

- 6** Select the zoom factor from the zoom setting screen.

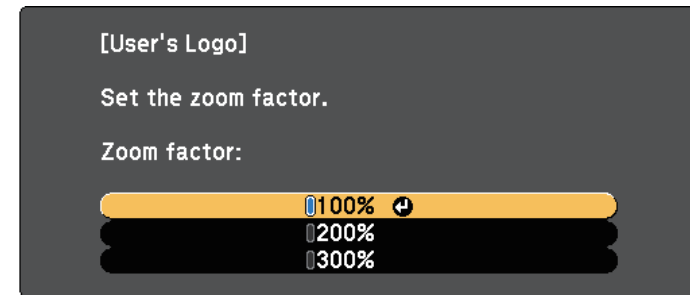

[Esc]:Return [◆]:Select [↵]:Set [Menu]:Exit

- 7** When the message "Save this image as the User's Logo?" is displayed, select **Yes**.

The image is saved. After the image has been saved, the message "Completed." is displayed.



- When a User's Logo is saved, the previous User's Logo is erased.
- It takes a while to save. Do not operate the projector or any connected equipment while it is saving, otherwise malfunctions may occur.

The projector has the following enhanced security functions.

- **Password Protect**
You can limit who can use the projector.
- **Control Panel Lock**
You can prevent people changing the settings on the projector without permission.
☛ "Restricting Operation (Control Panel Lock)" [p.73](#)
- **Anti-Theft Lock**
The projector is equipped with the following anti-theft security device.
☛ "Anti-Theft Lock" [p.74](#)

Managing Users (Password Protect)

When Password Protect is activated, people who do not know the password cannot use the projector to project images even if the projector power is on. Furthermore, the user's logo that is displayed when you turn on the projector cannot be changed. This acts as an anti-theft function as the projector cannot be used even if it is stolen. At the time of purchase, Password Protect is not activated.

Kinds of Password Protect

The following two kinds of Password Protect settings can be made according to how the projector is being used.

- **Power On Protect**
When **Power On Protect** is **On**, you need to enter a preset password after the projector is plugged in and turned on (this also applies to Direct Power On). If the correct password is not entered, projection does not start.

- **User's Logo Protection**

Even if someone tries to change the User's Logo set by the owner of the projector, it cannot be changed. When **User's Logo Protect** is set to **On**, the following setting changes for the User's Logo are prohibited.

- Capturing a User's Logo
- Setting **Display Background**, **Startup Screen**, or **A/V Mute** from **Display**
☛ **Extended - Display** [p.89](#)

- **Network Protection**

When **Network Protect** is set to **On**, changing the settings for **Network** is prohibited.

- ☛ "Network Menu" [p.90](#)

Setting Password Protect

Use the following procedure to set Password Protect.

- 1** During projection, hold down the [Freeze] button for about five seconds.

The Password Protect setting menu is displayed.

Remote control

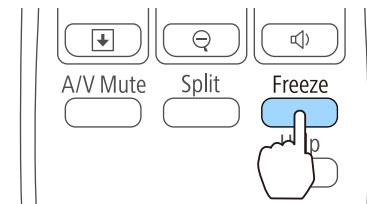



- If Password Protect is already activated, you must enter the password.
If the password is entered correctly, the Password Protect setting menu is displayed.
- ☛ "Entering the Password" p.72

- 2 Select the type of Password Protect you want to set, and then press the [↵] button.

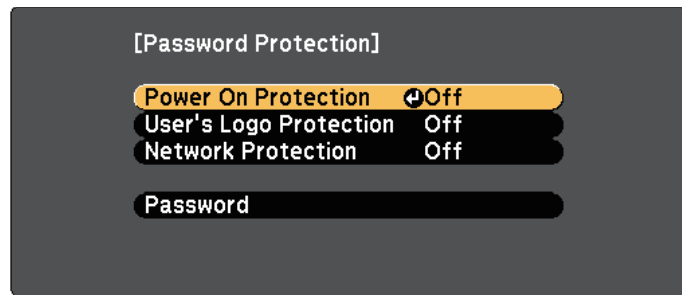

- 3 Select **On**, and then press the [↵] button.
Press the [Esc] button, the screen displayed in step 2 is displayed again.

- 4 Set the password.
 - (1) Select **Password**, and then press the [↵] button.
 - (2) When the message "Change the password?" is displayed, select **Yes** and then press the [↵] button. The default password is set to "0000". Change this to your own desired Password. If you select **No**, the screen displayed in step 2 is displayed again.
 - (3) While holding down the [Num] button, enter a four digit number using the numeric buttons. The number entered is displayed as "* * * *". When you enter the fourth digit, the confirmation screen is displayed.

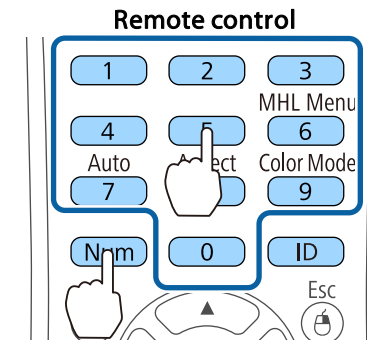

- (4) Re-enter the password.
The message "Password accepted." is displayed.
If you enter the password incorrectly, a message is displayed prompting you to re-enter the password.

Entering the Password

When the password entry screen is displayed, enter the password using the remote control.

While holding down the [Num] button, enter the password by pressing the numeric buttons.

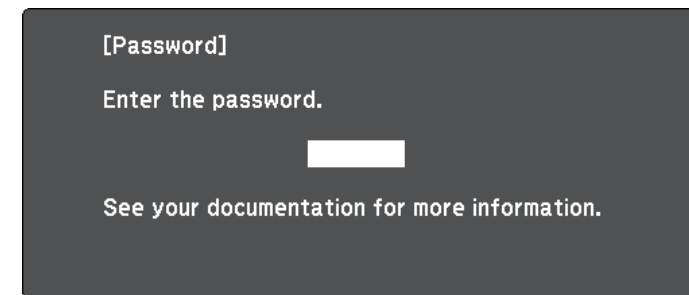

When you enter the correct password, Password Protect is temporarily released.

Attention

- If an incorrect password is entered three times in succession, the message "The projector's operation will be locked." is displayed for approximately five minutes, and then the projector switches to standby mode. If this happens, disconnect the power plug from the electrical outlet and then reinsert it and turn the projector's power back on. The projector displays the password entry screen again so that you can enter the correct password.
- If you have forgotten the password, make a note of the "Request Code: xxxxx" number that appears on the screen and contact the nearest address provided in the Epson Projector Contact List.
[Epson Projector Contact List](#)
- If you continue to repeat the above operation and enter the wrong password thirty times in succession, the following message is displayed and the projector does not accept any more password entries. "The projector's operation will be locked. Contact Epson as described in your documentation."
[Epson Projector Contact List](#)

Restricting Operation (Control Panel Lock)

Perform one of the following to lock the operation buttons on the control panel.

- **Full Lock**
 All of the buttons on the control panel are locked. You cannot perform any operations from the control panel, including turning the power on or off.
- **Partial Lock**
 All of the buttons on the control panel, except for the [⏻] power button, are locked.

This is useful at events or shows when you want to deactivate all buttons during projection or at schools when you want to limit button operation. The projector can still be operated using the remote control.

- 1 Press the [Menu] button while projecting.
 ➔ "Using the Configuration Menu" p.82

Using the remote control

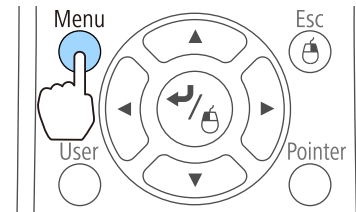

Using the control panel

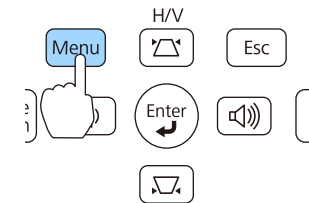

- 2 Select **Control Panel Lock** from **Settings**.

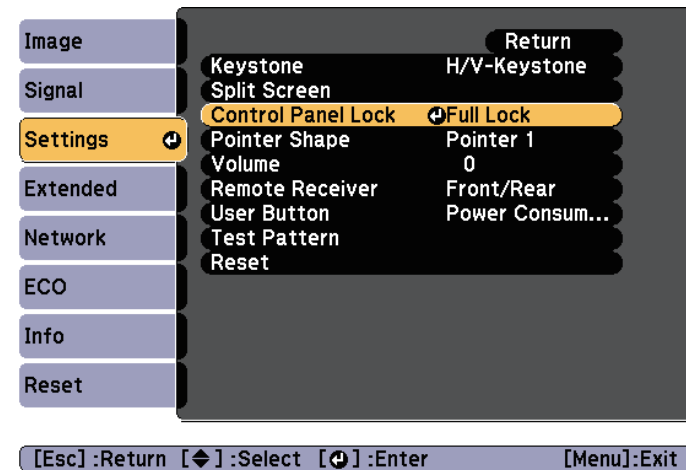

- 3 Select either **Full Lock** or **Partial Lock** according to your purpose.

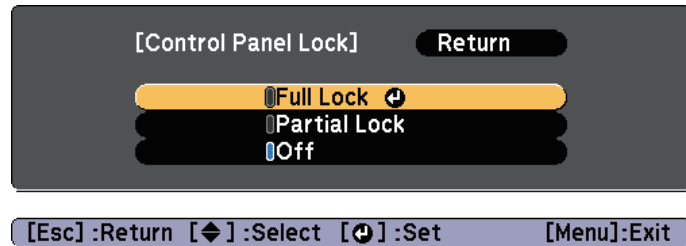

- 4** Select **Yes** when the confirmation message is displayed. The control panel buttons are locked according to the setting you chose.



You can release the control panel lock by one of the following two methods.

- Select **Off** from **Control Panel Lock**.
 [Settings - Control Panel Lock p.88](#)
- Press and hold down the [↵] button on the control panel for about seven seconds, a message is displayed and the lock is released.

Installing the wire lock

Pass an anti-theft wire lock through the projector.

See the documentation supplied with the wire lock for locking instructions.

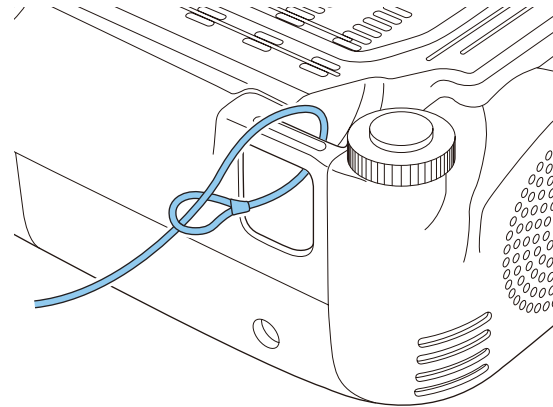

Anti-Theft Lock

The projector is equipped with the following types of anti-theft security devices.

- Security slot
 The security slot is compatible with the Microsaver Security System manufactured by Kensington.
 See the following for more details on the Microsaver Security System.
 <http://www.kensington.com/>
- Security cable installation point
 A commercially available theft-prevention wire lock can be passed through the installation point to secure the projector to a desk or pillar.

EasyMP Monitor

EasyMP Monitor lets you carry out operations such as checking the status of multiple Epson projectors that are connected to a network at a computer monitor, and controlling the projectors from the computer.

You can download EasyMP Monitor from the following Web site.

<http://www.epson.com>

The following provides descriptions of the monitoring and control functions that can be carried out using EasyMP Monitor.

- Registering projectors for monitoring and control
- Group registration for registered projectors
- Monitoring the status of registered projectors
- Controlling registered projectors
- Mail Notification settings
- Sending messages to registered projectors

Message Broadcasting

Message Broadcasting is plugin software for EasyMP Monitor. Message Broadcasting can be used to send a message (JPEG file) to project on all Epson projectors or specified projectors connected on the network.

The data can be sent manually, or sent automatically using Timer Settings of EasyMP Monitor.

Download the Message Broadcasting software from the following Web site.

<http://www.epson.com>

Changing Settings Using a Web Browser (Web Control)

By using a Web browser of a computer connected to the projector on a network, you can make settings and control the projector. This function

allows you to perform setup and control operations remotely. In addition, since you can use the computer's keyboard, entering characters required for the setup is easier.

Use Microsoft Internet Explorer 8.0 or later as the Web browser. Use Safari for OS X.



If you set **Standby Mode** to **Communication On**, you can use the Web browser to make settings and perform control even if the projector is in standby mode (when the power is off).

☛ **ECO - Standby Mode** [p.97](#)

Projector setup

In a Web browser, you can set items that are usually set in the projector's Configuration menu. The settings are reflected in the Configuration menu. There are also items that can only be set in the Web browser.

Items in the Configuration menu that cannot be set by the Web browser

- Settings Menu - Pointer Shape
- Settings Menu - Test Pattern
- Settings Menu - User Button
- Extended Menu - User's Logo
- Extended Menu - Language
- Reset Menu - Reset Lamp Hours

The settings for items on each menu are the same as the projector's Configuration menu.

☛ "Configuration Menu" [p.81](#)

Items that can only be set with a Web browser

- SNMP Community Name (up to 32 single-byte alphanumeric characters)
- Monitor Password (up to 16 single-byte alphanumeric characters)
- Add Port

- Port Number

Displaying the Web Control screen

Use the following procedure to display the Web Control screen.

Make sure the computer and projector are connected to the network. When communicating with a wireless LAN, connect in Advanced mode.



If your Web browser is set up to connect via a proxy server, the Web Control screen cannot be displayed. To display Web Control, you need to make settings so that a proxy server is not used for a connection.

- 1 Start a Web browser on the computer.
- 2 Enter the IP address of the projector in the address input box of the Web browser, and press the Enter key on the computer's keyboard.

The Web Control screen is displayed.

When Web Control Password is set from the Configuration menu, the password entry screen is displayed.

- 3 Enter the user ID and password.
Enter "EPSONWEB" as the user ID.
The initial password is "admin".



- Enter the user ID even if a password has not been set. You cannot change the user ID.
- You can change the password in Network menu from the Configuration menu.

🖱️ **Network - Basic - Web Control Password** [p.92](#)

Displaying the Web Remote screen

The Web Remote function allows you to perform projector remote control operations with a Web browser.

- 1 Display the Web Control screen.
- 2 Click **Web Remote**.

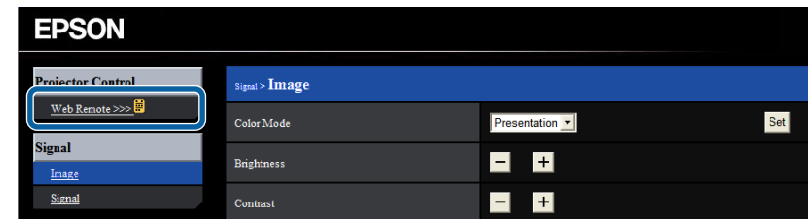

- 3 The Web Remote screen is displayed.

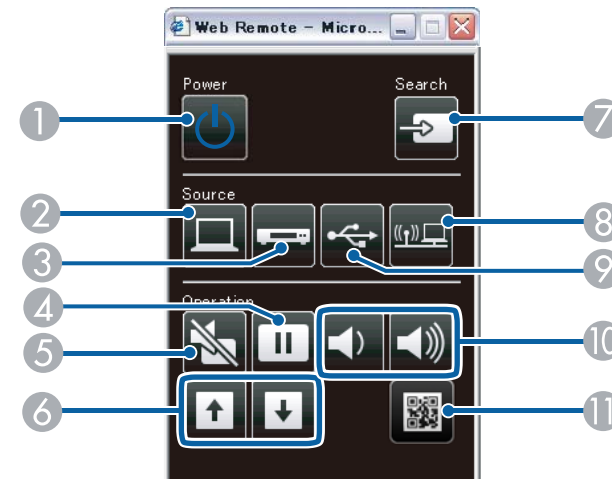

	Name	Function
1	Power button [⏻]	Turns the projector power on or off. 🖱️ "From Installation to Projection" p.32

Name	Function
② [Computer] button	Changes to images from the Computer port.
③ [Video] button	Each time the button is pressed, the image cycles through the Video, S-Video, and HDMI/MHL ports.
④ [Freeze] button	Images are paused or unpaused. ☛ "Freezing the Image (Freeze)" p.66
⑤ [A/V Mute] button	Turns the video and audio on or off. ☛ "Hiding the Image and Sound Temporarily (A/V Mute)" p.65
⑥ [Page] buttons [↑][↓]	Changes pages in files such as PowerPoint files when using the following projection methods. <ul style="list-style-type: none"> • When using the Wireless Mouse function ☛ "Using the Remote Control to Operate the Mouse Pointer (Wireless Mouse)" p.68 • When using USB Display ☛ "Projecting with USB Display" p.34 • During a network connection When projecting images or scenarios using PC Free, pressing these buttons displays the previous/next screen.
⑦ [Source Search] button	Changes to the next input source that is sending an image. ☛ "Automatically Detect Input Signals and Change the Projected Image (Source Search)" p.33
⑧ [LAN] button	Changes to the image projected with EasyMP Network Projection. When projecting using the optional Quick Wireless Connection USB Key, this button switches to that image. ☛ "Switching to the Target Image by Remote Control" p.34
⑨ [USB] button	Each time the button is pressed, it cycles through the following images: <ul style="list-style-type: none"> • USB Display • Images from the device connected to the USB port ☛ "Switching to the Target Image by Remote Control" p.34

Name	Function
⑩ [Volume] buttons [<] [>]	[<] Decreases the volume. [>] Increases the volume. ☛ "Adjusting the Volume" p.43
⑪ [Display the QR Code] button	Displays the QR code.

Using the Mail Notification Function to Report Problems

When you set Mail Notification, notification messages are sent to the preset email addresses when a problem or warning occurs with a projector. This will enable the operator to be notified of problems with projectors even at locations away from the projectors.

☛ **Network - Mail - Mail Notification** p.95



- Up to a maximum of three notification destinations (addresses) can be registered, and notification messages can be sent to all three destinations at once.
- If a projector develops a critical problem and suddenly stops working, it may not be able to send a message notifying an operator of the problem.
- If you set **Standby Mode** to **Communication On**, you can control the projector even if it is in standby mode (when the power is off).
☛ **ECO - Standby Mode** p.97

Reading Error Notification Mail

When the Mail Notification function is set to On and a problem or warning occurs in the projector, the following email will be sent.

Mail sender: Address for Address 1

Subject: EPSON Projector

Line 1: The projector name where the problem has occurred

Line 2: The IP address set for the projector where the problem has occurred.

Line 3 and on: Details of the problem

The details of the problem are listed line by line. The messages are listed below.

- Internal error
- Fan related error
- Sensor error
- Lamp cover is open
- Lamp timer failure
- Lamp out
- Internal temperature error
- High-speed cooling in progress
- Lamp replacement notification
- No-signal
No Signal is input to the projector. Check the connection status or check that the power for the signal source is turned on.
- Auto Iris Error
- Power Err. (Ballast)

See the following to deal with problems or warnings.

☛ "Reading the Indicators" [p.110](#)

Management Using SNMP

By setting **SNMP** to **On** in the Configuration menu, notification messages are sent to the specified computer when a problem or warning occurs. This will enable the operator to be notified of problems with projectors even at locations away from the projectors.

☛ [Network - Others - SNMP p.96](#)



- SNMP should be managed by a network administrator or someone who is familiar with the network.
- To use the SNMP function to monitor the projector, you need to install the SNMP manager program on your computer.
- The SNMP Agent for this projector complies with version 1 (SNMPv1).
- The managing function using SNMP cannot be used via wireless LAN in Quick mode.
- Up to two destination IP addresses can be saved.

ESC/VP21 Commands

You can monitor and control the projector from a computer via USB. Connect the device and the projector with a USB cable, and then enter the communication commands (ESC/VP21 commands).

Before starting

To control and monitor the projector using ESC/VP21 commands, the following preparations must be carried out.

1

Install the USB communication driver (EPSON USB-COM Driver) to your computer. For information about the EPSON USB-COM Driver,

contact your local dealer or the nearest address provided in the Epson Projector Contact List.

☛ [Epson Projector Contact List](#)

2 Set **USB Type B** to **Link 21L** from the projector's Configuration menu.

☛ [Extended - USB Type B p.89](#)

3 Connect the computer's USB port to the projector's USB-B port with a USB cable.

Start from step 2 from the second time.

Command list

When the power ON command is transmitted to the projector, the power turns on and it enters warm-up mode. When the projector's power has turned on, a colon ":" (3Ah) is returned.

When a command is input, the projector executes the command and returns a ":", and then accepts the next command.

If the command being processed terminates abnormally, an error message is output and a ":" is returned.

Item		Command	
Power ON/OFF	On	PWR ON	
	Off	PWR OFF	
Signal selection	Computer	Auto	SOURCE 1F
		RGB	SOURCE 11
		Component	SOURCE 14
	HDMI		SOURCE 30
	Video		SOURCE 41
	S-Video		SOURCE 42

Item		Command
	USB Display	SOURCE 51
	USB	SOURCE 52
	LAN	SOURCE 53
A/V Mute On/Off	On	MUTE ON
	Off	MUTE OFF
A/V Mute selection	Black	MSEL 00
	Blue	MSEL 01
	Logo	MSEL 02



Add a Carriage Return (CR) code (0Dh) to the end of each command and transmit.

Communications protocol

- Default baud rate setting: 9600 bps
- Data length: 8 bit
- Parity: None
- Stop-bit: 1 bit
- Flow control: None

Check the numbers and then apply the following countermeasures. If you cannot resolve the problem, contact your network administrator, or contact your local dealer or the nearest address provided in the Epson Projector Contact List.

 [Epson Projector Contact List](#)

Event ID	Cause	Remedy
0432 0435	Failed to startup EasyMP Network Projection.	Restart the projector.
0434 0481 0482 0485	Network communication is unstable.	Check the network communication status, and reconnect after waiting for a while.
0433	Cannot play transferred images.	Restart EasyMP Network Projection.
0484	Communication was disconnected from the computer.	
0483 04FE	EasyMP Network Projection ended unexpectedly.	Check the network communication status, and then restart the projector.
0479 04FF	A system error occurred in the projector.	Restart the projector.
0891	Cannot find an access point with the same SSID.	Set the computer, the access point, and the projector to the same SSID.
0892	The WPA/WPA2 authentication type does not match.	Check that the wireless LAN security settings are correct.
0893	The WEP/TKIP/AES encryption type does not match.	 Security p.94
0894	Communication was disconnected because the projector connected to an unauthorized access point.	Contact your network administrator for more information.
0898	Failed to acquire DHCP.	Check that the DHCP server is operating correctly. If you are not using DHCP, turn off the DHCP setting.  Wireless LAN - IP Settings p.93
0899	Other communication errors	If restarting the projector or EasyMP Network Projection does not solve the problem, contact your local dealer or the nearest address provided in the Epson Projector Contact List.  Epson Projector Contact List



Configuration Menu

This chapter explains how to use the Configuration menu and its functions.

This section explains how to use the Configuration menu.

Although steps are explained using the remote control as an example, you can perform the same operations from the control panel. Check the guide under the menu for the available buttons and their operations.

1 Display the Configuration menu screen.

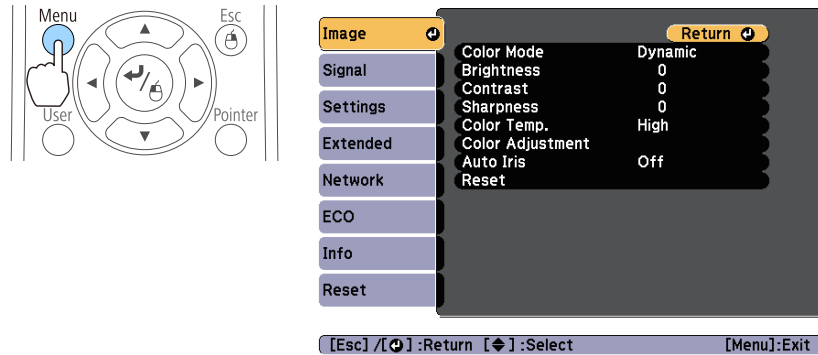

2 Select a top menu item.

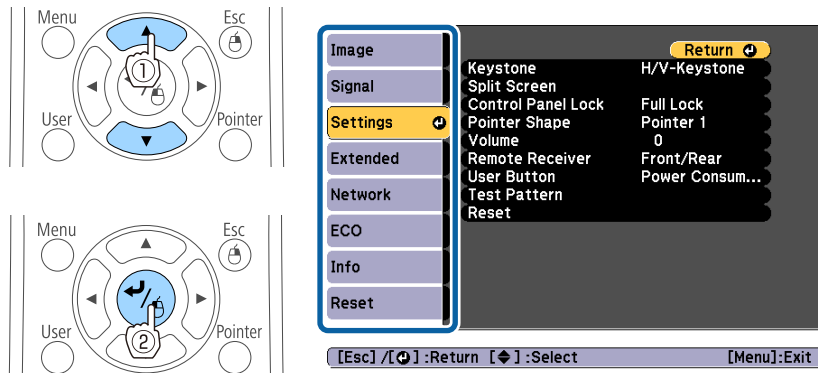

3 Select a submenu item.

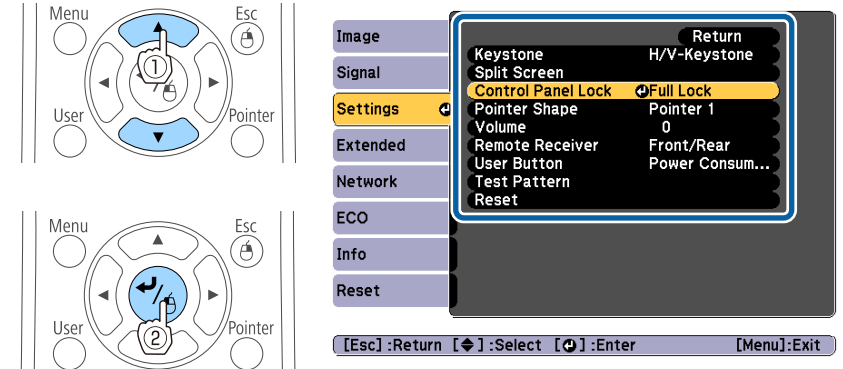

4 Change settings.

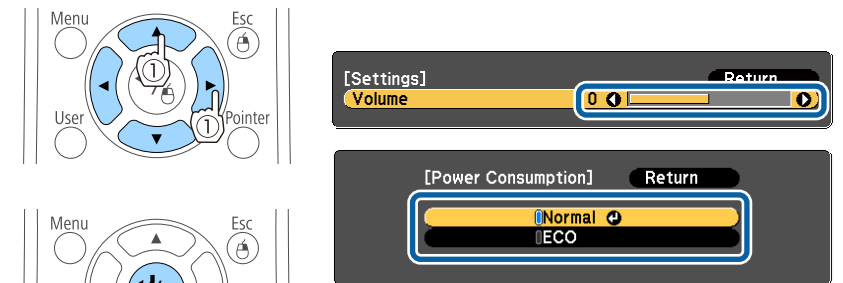

5 Press the [Menu] button to finish making settings.

Configuration Menu Table

Settable items vary depending on the model being used and the image signal and source being projected.

Top Menu Name	Submenu Name	Items or Setting Values
Image menu ☛ p.85	Color Mode	Dynamic, Living Room, Cinema, Game, 3D Dynamic, and 3D Cinema
	Brightness	-24 to 24
	Contrast	-24 to 24
	Color Saturation	-32 to 32
	Tint	-32 to 32
	Sharpness	-5 to 5
	Color Temp.	High, Medium, and Low
	Color Adjustment	Red: -16 to 16 Green: -16 to 16 Blue: -16 to 16
Auto Iris	Off, Normal, High Speed	
Signal menu ☛ p.85	3D Setup	3D Display, 2D-to-3D Conversion, 3D Format, 3D Depth, Diagonal Screen Size, 3D Brightness, Inverse 3D Glasses, 3D Viewing Notice
	Auto Setup	On and Off
	Resolution	Auto, Wide, and Normal
	Tracking	-
	Sync.	0 to 31
	Position	Up, Down, Left, and Right
	Progressive	Off, Video, and Film/Auto
Noise Reduction	Off, NR1, and NR2	

Top Menu Name	Submenu Name	Items or Setting Values
	HDMI Video Range	Auto, Normal, and Expanded
	Input Signal	Auto, RGB, and Component
	Video Signal	Auto, NTSC, NTSC4.43, PAL, M-PAL, N-PAL, PAL60, and SECAM
	Aspect	Normal, Auto, 16:9, Full, Zoom, and Native
	Overscan	Auto, Off, 4%, and 8%
	Turbo Mode	On and Off
Settings menu ☛ p.88	Keystone	H/V-Keystone and Quick Corner
	Split Screen	-
	Control Panel Lock	Full Lock, Partial Lock, and Off
	Pointer Shape	Pointer 1, Pointer 2, Pointer 3
	Volume	0 to 10
	Remote Receiver	Front/Rear, Front, Rear, and Off
	User Button	Power Consumption, Info, Progressive, Test Pattern, Resolution, 3D Format, Display the QR Code
	Test Pattern	-
Extended menu ☛ p.89	Display	Messages, Display Background, Startup Screen, and A/V Mute
	User's Logo	-
	Projection	Front, Front/Ceiling, Rear, and Rear/Ceiling
	Operation	Direct Power On, High Altitude Mode, Startup Source Search, Auto Power On
	USB Type B	USB Display and Link 21L

Top Menu Name	Submenu Name	Items or Setting Values
	Language	15 or 35 languages*
ECO menu ☛ p.97	Power Consumption	Normal and ECO
	Light Optimizer	On and Off
	Sleep Mode	On and Off
	Sleep Mode Timer	1 to 30
	Lens Cover Timer	On and Off
	A/V Mute Timer	On and Off
	Standby Mode	Communication On and Communication Off
	ECO Display	On and Off
Info menu ☛ p.98	Projector Info	Lamp Hours, Source, Input Signal, Resolution, Video Signal, Refresh Rate, 3D Format, Sync Info, Status, Serial Number, Event ID
	Version	-
Reset menu ☛ p.99	Reset All	-
	Reset Lamp Hours	-

* The number of supported languages differs depending on the region where the projector is used.

Network menu

Top Menu Name	Submenu Name	Setting Values
Basic menu ☛ p.92	Projector Name	-
	Web Control Password	-
	Projector Keyword	On and Off
	Display LAN Info.	Text & QR Code, Text
Wireless LAN menu	Connection Mode	Quick, Advanced

Top Menu Name	Submenu Name	Setting Values
☛ p.93	Channel	1ch, 6ch, 11ch
	SSID Auto Setting	On and Off
	SSID	-
	Search Access Point	-
	IP Settings	DHCP, IP Address, Subnet Mask, and Gateway Address
	SSID Display	On and Off
	IP Address Display	On and Off
	Security menu ☛ p.94	Security
Passphrase		-
Mail menu ☛ p.95	Mail Notification	On and Off
	SMTP Server	-
	Port Number	-
	Address 1 Setting, Address 2 Setting, and Address 3 Setting	-
Others menu ☛ p.96	SNMP	On and Off
	Trap IP Address 1 and Trap IP Address 2	-
	Bonjour	On and Off
	Message Broadcasting	On and Off

Image Menu

Settable items vary depending on the image signal and source currently being projected. Setting details are saved for each image signal.

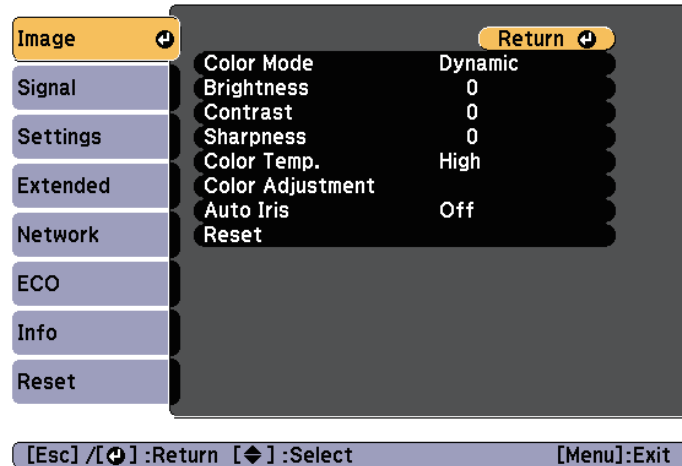

Submenu	Function
Color Mode	You can select the quality of the image to suit your surroundings. ☛ "Selecting the Projection Quality (Selecting Color Mode)" p.43
Brightness	You can adjust the image brightness.
Contrast	You can adjust the difference between light and dark in the images.
Color Saturation	You can adjust the color saturation for the images.
Tint	(Adjustment is possible when a component video signal is being input. If a composite video or S-video signal is input, adjustment is only possible when NTSC signals are being input.) You can adjust the image tint.
Sharpness	You can adjust the image sharpness.

Submenu	Function
Color Temp.	Adjusts the tint for the images. You can adjust tints in three stages from High , Medium , and Low . The image is tinted blue when High is selected, and tinted red when Low is selected.
Color Adjustment	You can adjust the color strength for Red , Green , and Blue individually.
Auto Iris	Set to Normal or High Speed to adjust the iris to obtain the optimum light for images being projected. Select High Speed to make faster iris corrections to match the speed of the scene. The setting is stored for each Color Mode. ☛ "Setting Auto Iris" p.44
Reset	You can reset all adjustment values for the Image menu to their default settings. See the following to return all menu items to their default settings. ☛ "Reset Menu" p.99

Signal Menu

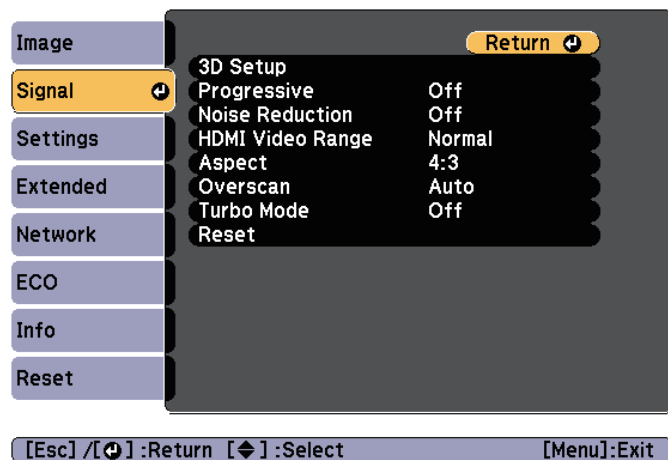

Settable items vary depending on the image signal and source currently being projected. Setting details are saved for each image signal.

You cannot make settings on the Signal menu when the source is USB Display, USB, or LAN.



Submenu	Function
Auto Setup	Set to On to automatically adjust Tracking, Sync., and Position to the optimum state when the input signal changes.
Resolution	Set to Auto to automatically identify the resolution of the input signal. If images are not projected correctly when set to Auto , for example if some of the image is missing, adjust to Wide for wide screens, or set to Normal for 4:3 or 5:4 screens depending on the connected computer.
Tracking	You can adjust computer images when vertical stripes appear in the images.
Sync.	You can adjust computer images when flickering, fuzziness, or interference appear in the images.
Position	You can adjust the display position up, down, left, and right when a part of the image is missing so that the whole image is projected.

Submenu	Function
3D Setup	<p>Set when viewing 3D images.</p> <p>3D Display: Set to On when viewing 3D content. If this is set to Off, 2D images are projected even when a 3D input signal is being input.</p> <p>2D-to-3D Conversion: (This item can only be set if 3D Display is set to On, and 3D Format is set to Auto or 2D.) Converts 2D images to 3D images, and then projects. You can select the strength from Weak, Medium, or Strong.</p> <p>3D Format: Select the format for the 3D input signal. When set to Auto, the format is chosen automatically according to the input signal. Normally this should be set to Auto.</p> <p>3D Depth: Sets the depth of the 3D image.</p> <p>Diagonal Screen Size: Sets the projection size for the 3D image. By matching the actual 3D image size, you can project a 3D image that is a faithful reproduction of the original contents.</p> <p>3D Brightness: Adjust the brightness of the projected image.</p> <p>Inverse 3D Glasses: The shutter opening timing for the 3D Glasses is inverted from left to right. Use this if you cannot view the 3D image correctly.</p> <p>3D Viewing Notice: Set to On to display warnings regarding viewing 3D images. Displays warnings when viewing 3D images.</p>
Progressive	<p>(When a component video or RGB video is being input, this setting can only be adjusted if the signal being input is an interlaced signal (480i/576i/1080i). This cannot be set when a digital RGB signal is being input.)</p> <p><u>Interlace</u> (i) signal is converted to <u>Progressive</u> (p). (IP conversion)</p> <p>Off: Ideal for images with a large amount of movement.</p> <p>Video: Ideal for general video images.</p> <p>Film/Auto: This is ideal for movie films, computer graphics, and animation.</p>



Submenu	Function
Noise Reduction	(This cannot be set when a digital RGB signal is input, when projecting an interlaced signal while Progressive is set to Off .) (This item cannot be selected if Color Mode is set to Game .) Smooths out rough images. There are two modes. Select your favorite setting. It is recommended that this is set to Off when viewing image sources in which noise is very low, such as for DVDs.
HDMI Video Range	When the projector's HDMI/MHL port is connected to a DVD player, set the projector's video range according to the DVD player's video range setting.
Input Signal	You can select input signal from Computer port. If set to Auto , the input signal is set automatically according to the connected equipment. If colors do not appear correctly when set to Auto , select the appropriate signal according to the connected equipment.
Video Signal	You can select the input signal from the Video port. If set to Auto , video signals are recognized automatically. If interference appears in the image or a problem occurs such as no image is being projected when set to Auto , select the appropriate signal according to the connected equipment.
Aspect	You can set the <u>aspect ratio</u>  for projected images.  "Changing the Aspect Ratio of the Projected Image" p.44
Overscan	Changes the output image ratio (the range of the projected image). You can set the cropping range to Off , 4% , or 8% . When the source is HDMI, Auto is available. When Auto is selected, it automatically changes to Off or 8% according to the input signal.
Turbo Mode	(This item can only be set if Color Mode is set to Game .) This speeds up the image display. If you are concerned about a lag in graphics, set this to On . When this is set to On , H-Keystone and Quick Corner are disabled.

Submenu	Function
Reset	You can reset all adjustment values on the Signal menu to their default settings, except for Input Signal . See the following to return all menu items to their default settings.  "Reset Menu" p.99

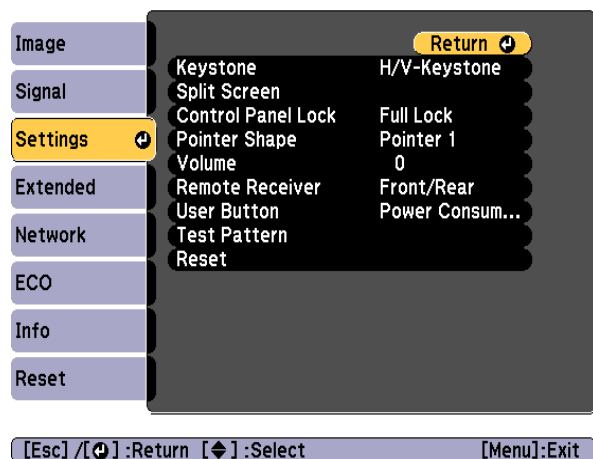
Settings Menu



Submenu	Function
Keystone	<p>You can correct keystone distortion.</p> <ul style="list-style-type: none"> When H/V-Keystone is selected: Adjust V-Keystone and H-Keystone to correct horizontal and vertical keystone distortion. You can also set H-Keystone Adjuster and Auto V-Keystone to On or Off. When Quick Corner is selected: Select and correct the four corners of the projected image. ☛ "Quick Corner" p.40
Split Screen	<p>Switches to split screen projection.</p> <p>☛ "Projecting Two Images Simultaneously (Split Screen)" p.48</p>
Control Panel Lock	<p>You can use this to restrict operation of the projector's control panel.</p> <p>☛ "Restricting Operation (Control Panel Lock)" p.73</p>

Submenu	Function
Pointer Shape	<p>You can select the shape of the pointer.</p> <p>Pointer 1: </p> <p>Pointer 2: </p> <p>Pointer 3: </p> <p>☛ "Pointer Function (Pointer)" p.66</p>
Volume	<p>You can adjust the volume. Setting values are saved for each source.</p>
Remote Receiver	<p>You can limit the reception of the operation signal from the remote control.</p> <p>When set to Off, you cannot perform any operations from the remote control. If you want to make operations from the remote control, hold down the [Menu] button on the remote control for at least 15 seconds to reset the setting to its default value.</p>
User Button	<p>You can select and assign an item from the Configuration menu with the remote control's [User] button. Pressing the [User] button directly displays the assigned menu item selection/adjustment screen, allowing you to make one-touch changes to settings/adjustments. You can assign one of the following items to the [User] button.</p> <p>Power Consumption, Info, Progressive, Test Pattern, Resolution, 3D Format, Display the QR Code</p>
Test Pattern	<p>You can display a test pattern to adjust the projection without connecting other equipment when you set up the projector. While the test pattern is displayed, zoom, focus adjustments, and keystone correction can be performed. To cancel the test pattern, press the [Esc] button on the remote control or the control panel.</p> <div style="border: 1px solid black; padding: 5px; margin-top: 10px;"> <p>Attention</p> <p>If a pattern is displayed for a long time, a residual image may be visible in projected images.</p> </div>

Submenu	Function
Reset	<p>You can reset all adjustment values on the Settings menu to their default settings, except for User Button.</p> <p>See the following to return all menu items to their default settings.</p> <p>☛ "Reset Menu" p.99</p>

Extended Menu

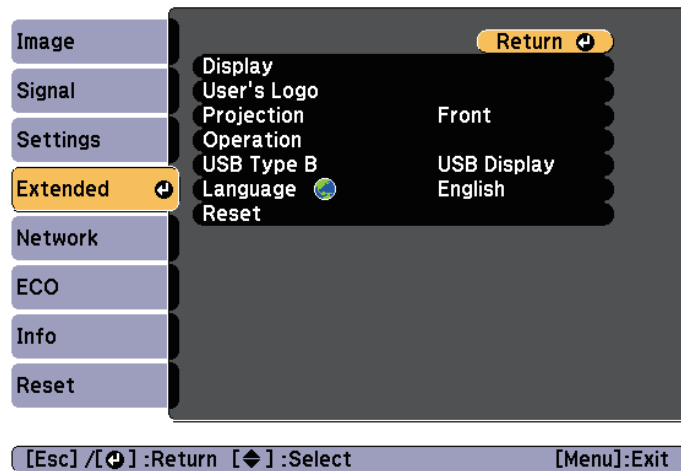

Submenu	Function
Display	<p>You can make settings related to the projector's display.</p> <p>Messages: When set to Off, the following items will not be displayed.</p> <p>Item names when the Source, Color Mode, or Aspect Ratio is changed, messages when no signal is being input, and warnings such as High Temp Warning.</p> <p>Display Background*1: You can set the screen background to Black, Blue, or Logo when no image signal is available.</p> <p>Startup Screen*1: Set to On to display the User's Logo when projection starts.</p> <p>A/V Mute*1: You can set the screen displayed when the remote control's [A/V Mute] button is pressed to Black, Blue, or Logo.</p>
User's Logo*1	<p>You can change the user's logo that is displayed as a background during Display Background, A/V Mute, and so on.</p> <p>☛ "Saving a User's Logo" p.69</p>
Projection	<p>Select from one of the following projection methods depending on how the projector is installed.</p> <p>Front, Front/Ceiling, Rear, and Rear/Ceiling</p> <p>You can change the setting as follows by pressing down the [A/V Mute] button on the remote control for about five seconds.</p> <p>Front ↔ Front/Ceiling Rear ↔ Rear/Ceiling</p> <p>☛ "Installation Methods" p.21</p>

Submenu	Function
Operation	<p>Direct Power On: Set to On to turn on the projector simply by plugging it in. When the power cord is plugged in, note that the projector turns on automatically in cases such as a power outage being restored.</p> <p>High Altitude Mode: Set to On when using the projector above an altitude of 1500 m.</p> <p>Startup Source Search: Set to On to project images from the port currently receiving an image when the projector starts. Set to Off to project images from the same source as the last time the projector was used.</p> <p>Auto Power On: (Only available when Standby Mode is set to Communication On.) When set to Computer, if the projector receives an image signal from the computer port when it is in standby status, the projector turns on.</p>
USB Type B	<p>USB Display: Enables USB Display. ☛ "Projecting with USB Display" p.34</p> <p>Link 21L: Enables ESC/VP21 commands. ☛ "ESC/VP21 Commands" p.78</p>
Language	You can set the language for messages and menus.
Reset	<p>You can reset the adjustment values for Display*1 and Operation*2 from the Extended menu to their default settings.</p> <p>See the following to return all menu items to their default settings. ☛ "Reset Menu" p.99</p>

*1 When **User's Logo Protect** is set to **On** in **Password Protect**, settings related to user's logo cannot be changed. You can make changes after setting **User's Logo Protect** to **Off**.

☛ "Managing Users (Password Protect)" p.71

*2 Except for High Altitude Mode and Startup Source Search.

Network Menu

When **Network Protect** is set to **On** in **Password Protect**, a message is displayed and the network settings cannot be changed. Set **Network Protect** to **Off** and then configure the network.

☛ "Setting Password Protect" p.71

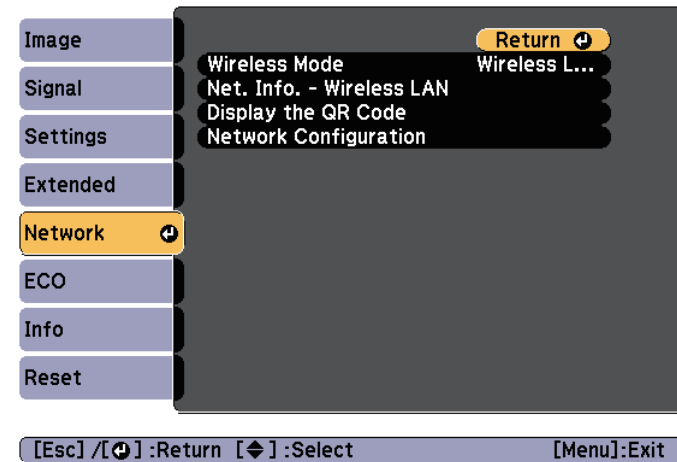

Submenu	Function
Wireless Power	Set Wireless LAN On when connecting the projector to the computer over wireless LAN. If you do not want to connect via wireless LAN, turn it Off to prevent unauthorized access by others. The default value is Wireless LAN On .

Submenu	Function
Net. Info. - Wireless LAN	Displays the following network setting status information. <ul style="list-style-type: none"> • Connection Mode • Wireless LAN system • Antenna Level • Projector Name • SSID • DHCP • IP Address • Subnet Mask • Gateway Address • MAC Address • Region Code*
Display the QR Code	Displays the QR code.
Network Configuration	The following menus are available for setting Network items. Basic, Wireless LAN, Security, Mail, Others, Reset, and Setup complete

* Displays available region information for the Wireless LAN unit being used. For more details, contact your local dealer or the nearest address provided in the Epson Projector Contact List.

[Epson Projector Contact List](#)



- By using a Web browser of a computer connected to the projector on a network, you can set functions and control the projector. This function is called Web Control. You can easily enter text using a keyboard to make settings for Web Control such as Security settings.
 - "Changing Settings Using a Web Browser (Web Control)" p.75
- Contact your network administrator for details on network settings.

Notes on operating the Network menu

Selecting from the top menu and sub menus, and changing selected items is the same as making operations from the Configuration menu.

When done, make sure you go to the **Complete** menu, and select **Yes**, **No**, or **Cancel**. When you select **Yes** or **No**, you are returned to the Configuration menu.

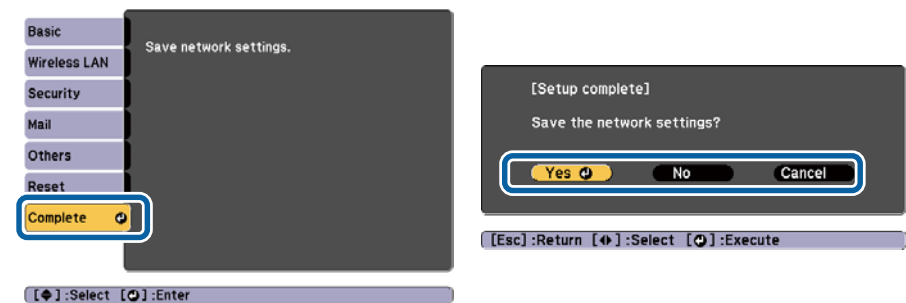







Yes: Saves the settings and exits the Network menu.

No: Does not save the settings and exits the Network menu.

Cancel: Continues displaying the Network menu.

Soft keyboard operations

The Network menu contains items that require input of alphanumeric during setup. In this case, the following software keyboard is displayed.

Press the [][][][] buttons on the remote control or the [][] buttons on the control panel. Use the buttons to move the cursor to the desired key, and then press the [] button to enter the selected character. Enter figures by holding down the [Num] button on the remote control, and pressing the numeric buttons. After inputting, press **Finish** on the keyboard to confirm your input. Press **Cancel** on the keyboard to cancel your input.

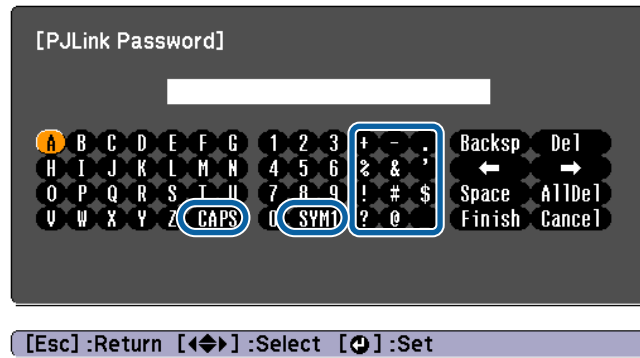

- Each time the **CAPS** key is selected and the [↵] button is pressed, it sets and changes between upper case and lower case letters.
 - Each time the **SYM1/2** key is selected and the [↵] button is pressed, it sets and changes the symbol keys for the section enclosed by the frame.
- The following text can be entered.

Numbers	0123456789
Alphabet	ABCDEFGHIJKLMNOPQRSTUVWXYZ abcdefghijklmnopqrstuvwxyz
Symbols	! # \$ % & ' () + - . / < = > ? @ ^ _ ` { } ~



- Except for the **SSID**, colons and spaces cannot be entered on the Network menu.
- Some symbols (" * , ; [\]) cannot be entered using the software keyboard. Use your Web browser to enter the text.
- "Changing Settings Using a Web Browser (Web Control)" [p.75](#)

Basic menu

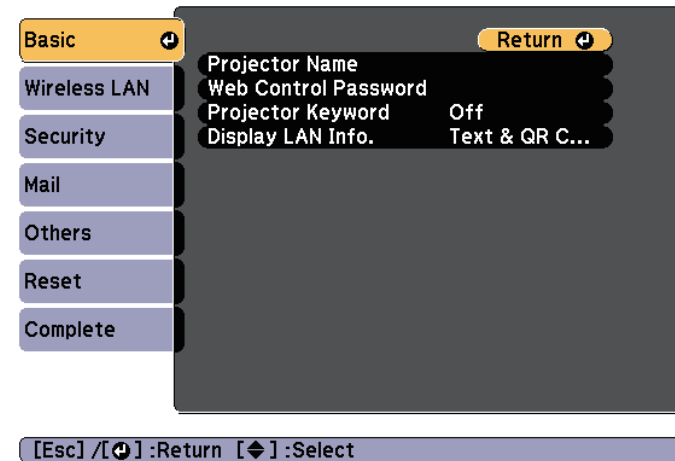

Submenu	Function
Projector Name	Displays the projector name used to identify the projector when connected to a network. When editing, you can enter up to 16 single-byte alphanumeric characters. The following characters cannot be used: " * + , / ; < = > ? [\] `
Web Control Password	Set a password to use when making settings and controlling the projector using Web Control. You can enter up to eight single-byte alphanumeric characters (* cannot be used). Web Control is a computer function that allows you to set up and control the projector by using the Web browser on a computer connected on a network. • "Changing Settings Using a Web Browser (Web Control)" p.75
Projector Keyword	When set to On , you have to enter the keyword when you try to connect the projector to a computer via a network. As a result, you can prevent presentations from being interrupted by connections from other computers. Normally this should be set to On .

Submenu	Function
Display LAN Info.	Set the display format for the projector's network information. When a QR code is displayed, you can connect to the network by simply reading the QR code with Epson iProjection. The default value is Text & QR Code . ☛ "Projecting Using a QR Code" p.63

Wireless LAN menu

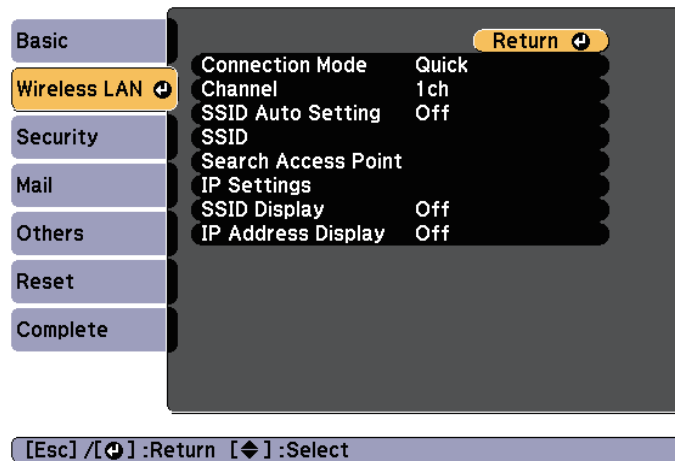

Submenu	Function
Connection Mode	Set the connection mode to use when connecting the projector and a computer via a wireless LAN. If you select Quick , a small network is created automatically by the projector and computer. It is used with EasyMP Network Projection. If SSID Auto Setting is set to On , the projector becomes an easy access point; if it is set to Off , the network is created in Ad hoc mode . If you select Advanced , the connection is established in Infrastructure mode through the access point installed.

Submenu	Function
Channel	(This can only be set if Connection Mode is set to Quick .) Select the frequency band used by the wireless LAN from 1ch , 6ch , or 11ch . The default value is 11ch .
SSID Auto Setting	(This can only be set if Connection Mode is set to Quick .) When you set this to On , you can search for the projector more quickly from among multiple projectors. SSID is set automatically. When connecting to multiple projectors from one computer in Quick mode, set this to Off , and set the same SSID in all the projectors that will connect.
SSID	(This item can only be set when SSID Auto Setting is set to Off .) Enter an SSID . When an SSID is provided for the wireless LAN system in which the projector participates, enter the SSID. You can enter up to 32 single-byte alphanumeric characters (: ^ can only be entered from the Web browser).
Search Access Point	(This item can be set only if Wireless Power is set to Wireless LAN On , and Connection Mode is set to Advanced .) The projector searches for a local access point. This allows you to perform wireless LAN setup by simply selecting the connection location of the wireless LAN.

Submenu	Function
IP Settings	<p>(This item can only be set if Connection Mode is set to Advanced.)</p> <p>You can make network settings.</p> <p>DHCP: Set to On to make network settings using DHCP. If this is set to On, you cannot set any more addresses.</p> <p>IP Address: You can input the IP address assigned to the projector. You can enter a number from 0 to 255 in each field of the address. However, the following IP addresses cannot be used. 0.0.0.0, 127.x.x.x, 224.0.0.0 to 255.255.255.255 (where x is a number from 0 to 255)</p> <p>Subnet Mask: You can input the subnet mask for the projector. You can enter a number from 0 to 255 in each field of the address. However, the following subnet masks cannot be used. 0.0.0.0, 255.255.255.255</p> <p>Gateway Address: You can input the IP address for the gateway for the projector. You can enter a number from 0 to 255 in each field of the address. However, the following Gateway addresses cannot be used. 0.0.0.0, 127.x.x.x, 224.0.0.0 to 255.255.255.255 (where x is a number from 0 to 255)</p>
SSID Display	To prevent the SSID from being displayed on the LAN Standby screen, set this to Off .
IP Address Display	To prevent the IP address from being displayed on the LAN Standby screen, set this to Off .

Security menu

Available when the Wireless LAN unit is installed.

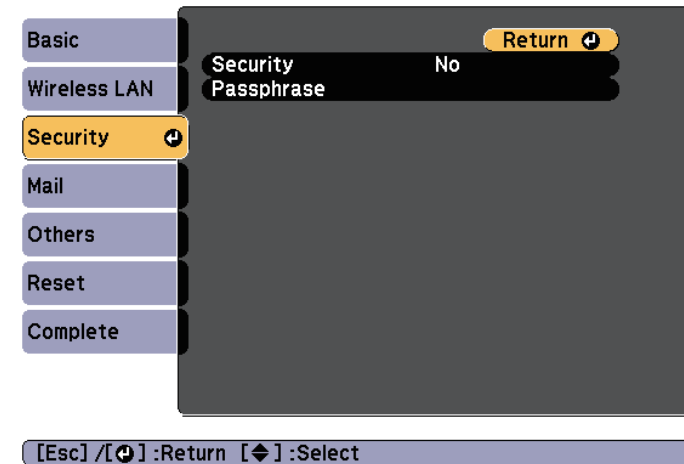

Submenu	Function
Security	Select the security type from the items that are displayed. When setting up Security, follow the instructions from the administrator of the network system you are about to access.

Submenu	Function
Passphrase	<p>Enter the passphrase. You can enter at least 8 and up to 63 single-byte alphanumeric characters.</p> <p>When using it with EasyMP Network Projection, you do not need to input the passphrase in the computer if it is the initial (default) passphrase.</p> <p>In the interests of security, we recommended that you change the passphrase periodically. If the network settings are initialized, it returns to the initial passphrase.</p> <p>☛ "Reset menu" p.97</p> <p>You can enter up to 32 characters on the Configuration menu. When entering more than 32 characters, use your Web browser to enter the text.</p> <p>☛ "Changing Settings Using a Web Browser (Web Control)" p.75</p> <p>In Quick mode, the initial passphrase is set.</p>

Type of security

When the Wireless LAN unit is installed, it is strongly recommended that you set security.

WPA is an encryption standard that improves the security for wireless networks. The projector supports TKIP and AES encryption methods.

WPA also includes user authentication functions. WPA authentication provides two methods: using an authentication server, or authenticating between a computer and an access point without using a server. This projector supports the latter method, without a server.



For setting details, follow the directions from the network administrator of your network.

Mail menu

When this is set, you receive an email notification if a problem or warning occurs in the projector.

☛ "Using the Mail Notification Function to Report Problems" p.77

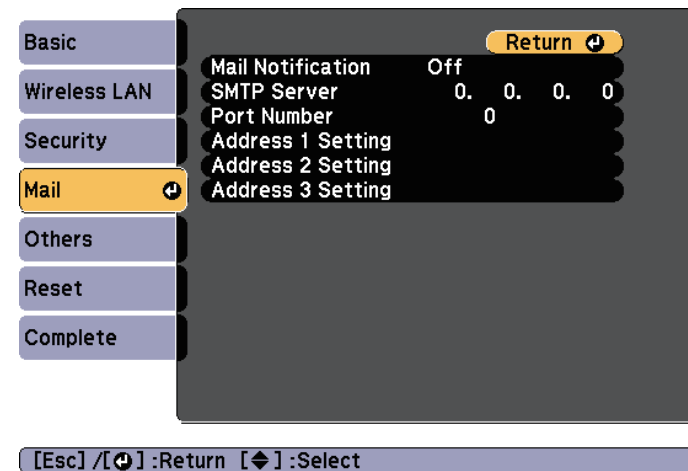

Submenu	Function
Mail Notification	Set to On to send an email to the preset addresses when a problem or warning occurs with a projector.
SMTP Server	<p>You can input the <u>IP address</u> for the SMTP server for the projector.</p> <p>You can enter a number from 0 to 255 in each field of the address. However, the following IP addresses cannot be used.</p> <p>127.x.x.x, 224.0.0.0 to 255.255.255.255 (where x is a number from 0 to 255)</p>
Port Number	You can input the port number for the SMTP server. The default value is 25. You can input numbers between 1 to 65535.

Submenu	Function
Address 1 Setting/Address 2 Setting/Address 3 Setting	<p>You can input the email address of the destination to send the notification email to. You can register up to three destinations. You can enter up to 32 single-byte alphanumeric characters for the email address. The following characters cannot be used: " () , ; < > [\]</p> <p>You can select the problems or warnings to be notified about by email. When the selected problem or warning occurs in the projector, an email is sent to the specified destination address notifying that a problem or warning has occurred. You can select multiple items from the displayed items.</p>

Others menu

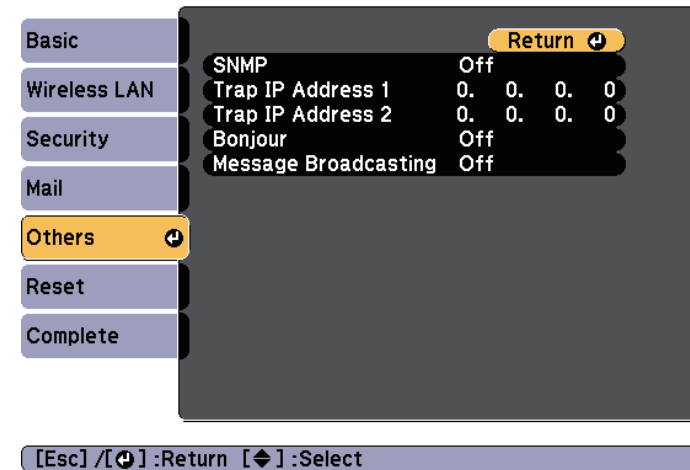

Submenu	Function
SNMP	<p>Set to On to monitor the projector using SNMP.</p> <p>To monitor the projector, you need to install the SNMP manager program on your computer. SNMP should be managed by a network administrator.</p> <p>The default value is Off.</p>
Trap IP Address 1/Trap IP Address 2	<p>You can register up to two IP addresses for the SNMP trap notification destination. You can enter a number from 0 to 255 in each field of the address. However, the following IP addresses cannot be used. 127.x.x.x, 224.0.0.0 to 255.255.255.255 (where x is a number from 0 to 255)</p>
Bonjour	<p>Set this to On when connecting to the network using Bonjour. See Apple's Web site for more information on the Bonjour service.</p> <p>http://www.apple.com/</p>
Message Broadcasting	<p>You can switch the EPSON Message Broadcasting function to enable or disable.</p>

Reset menu

Resets all of the network settings.

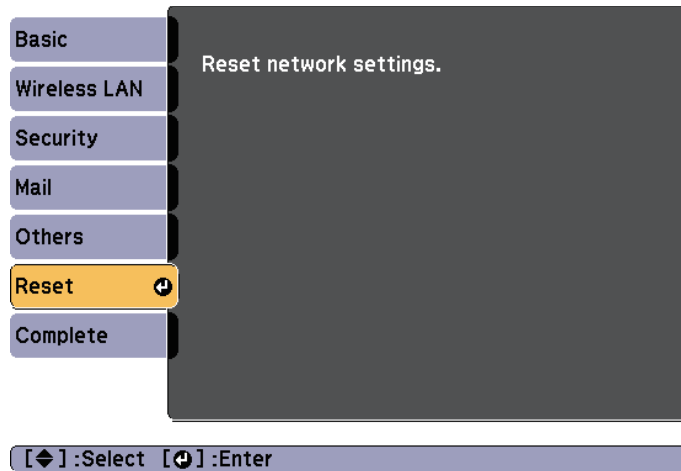

Submenu	Function
Reset network settings.	To reset all of the Network settings, select Yes .

ECO Menu

When you make ECO menu settings, the projector performs functions to save power. When power saving settings have been enabled, a leaf icon is displayed next to each submenu.

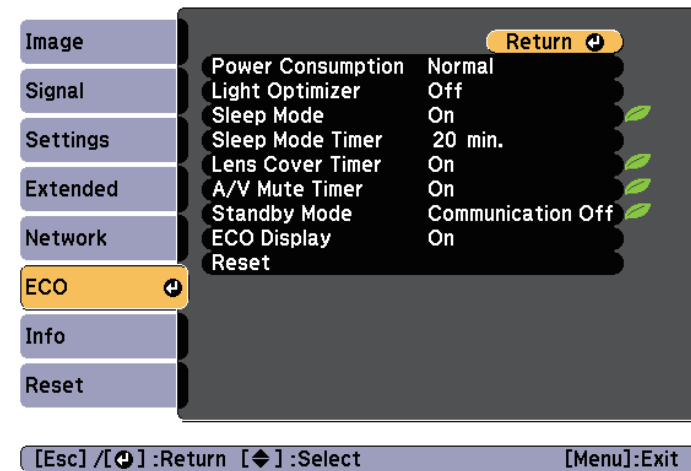

Submenu	Function
Power Consumption	You can set the lamp brightness to one of two settings. Select ECO if the images being projected are too bright, such as when projecting images in a dark room or onto a small screen. When ECO is selected, power consumption during projection decreases, and fan rotation noise is reduced. When using at high altitude or in locations subject to high temperatures, you may not be able to change settings.
Light Optimizer	(This item can only be set when Power Consumption is set to Normal .) When set to On , the lamp brightness is adjusted according to the image being projected. This helps to reduce the amount of electricity being used by lowering the lamp's brightness according to the scene being projected. The setting is stored for each Color Mode.

Submenu	Function
Sleep Mode	When set to On , this automatically stops projection when no image signal is being input and no operations are carried out for a specified length of time. Also, if no image signal is input for approximately five minutes, the lamp dims until the power turns off. When an image signal is input, the projector returns to normal operating status.
Sleep Mode Timer	When Sleep Mode is set to On , you can set the time before the projector automatically turns off within a range of 1 to 30 minutes.
Lens Cover Timer	When set to On , this turns off the power automatically 30 minutes after the lens cover is closed. Also, if the lens cover is closed for approximately five minutes, the lamp dims until the power turns off. When the lens cover is opened, the projector returns to normal operating status.
A/V Mute Timer	When set to On , this turns off the power automatically 30 minutes after A/V mute is enabled. Also, if A/V mute is enabled, the lamp dims until the power turns off. When A/V mute is disabled, the projector returns to normal operating status.
Standby Mode	When set to Communication On , you can monitor and control the projector from a computer, even if the projector is in standby mode. ☛ "Monitoring and Controlling" p.75
ECO Display	When set to On , when the lamp brightness changes from normal to low or low to normal, leaf icons are displayed at the bottom-left of the projected screen to indicate the power-saving status.
Reset	You can reset all adjustment values for the ECO menu to their default settings. See the following to return all menu items to their default settings. ☛ "Reset Menu" p.99

Info Menu (Display Only)

Lets you check the status of the image signals being projected and the status of the projector. Items that can be displayed vary depending on the source currently being projected. Depending on the model used, some input sources are not supported.

☛ "Automatically Detect Input Signals and Change the Projected Image (Source Search)" p.33

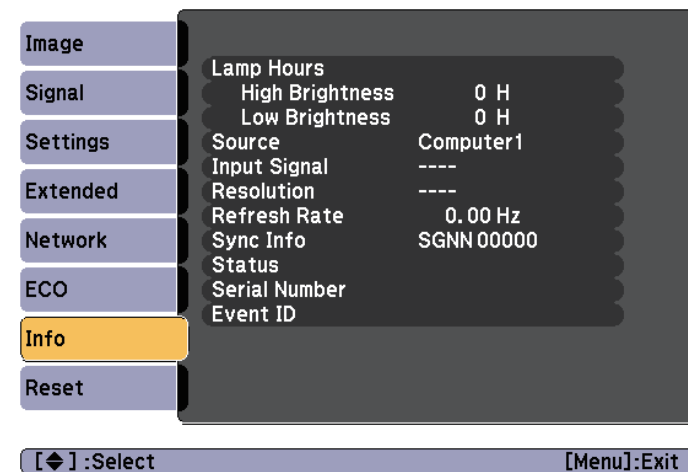

Submenu	Function
Projector Info	<p>You can display the following information.</p> <ul style="list-style-type: none"> • Lamp Hours* • Source • Input Signal • Resolution • Video Signal • Refresh Rate • 3D Format • Sync Info • Status • Serial Number • Event ID
Version	Displays the projector's firmware version.

* The cumulative use time is displayed as "0H" for the first 10 hours. 10 hours and above is displayed as "10H", "11H", and so on.

Reset Menu

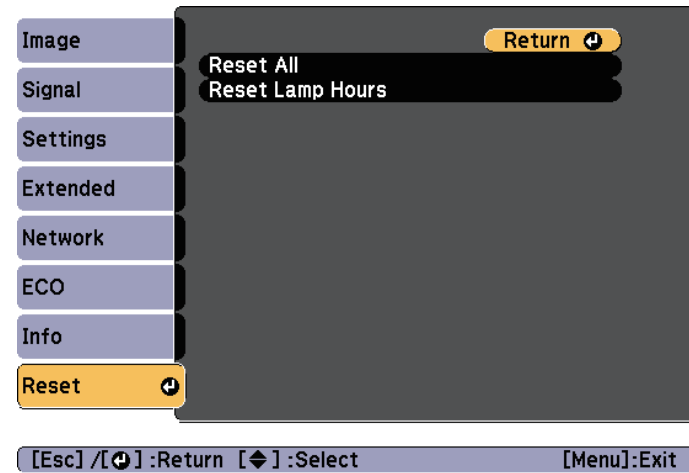

Submenu	Function
Reset All	<p>You can reset all items in the Configuration menu to their default settings.</p> <p>The following items are not reset to their defaults: Input Signal, User's Logo, Lamp Hours, Language, Password, User Button, and all items on the Network menu.</p>
Reset Lamp Hours	Clears the cumulative lamp hours use time. Reset when you replace the lamp.

Once the Configuration menu content has been set for one projector, you can use it to perform batch setup for multiple projectors (batch setup function). The batch setup function is only for projectors with the same model number.

Use one of the following methods.

- Setup using a USB flash drive.
- Setup by connecting the computer and projector with a USB cable.

This manual explains the USB flash drive and the USB cable methods.



- The following content is not reflected by the batch setup function.
 - Settings in the Network menu (except for the Mail menu and the Others menu)
 - Lamp Hours and status from the Info menu
- Perform batch setup before adjusting the projected image. Adjustment values for the projected image, such as H/V-Keystone correction, are reflected by the batch setup function. If batch setup is performed after adjusting the projected image, the adjustments you made may change.
- By using the batch setup function, the registered User's Logo is set for the other projectors. Do not register confidential information and so on as the User's Logo.



Caution

Performing batch setup is the customers responsibility. If batch setup fails due to a power failure, communication error, and so on, the customer is responsible for any repair costs incurred.

Setup Using a USB Flash Drive

This section explains how to perform batch setup using a USB flash drive.



- Use a FAT format USB flash drive.
- The batch setup function cannot be used by USB flash drives that incorporate security functions. Use a USB flash drive that does not incorporate security functions.
- The batch setup function cannot be used by USB card readers or USB hard disks.

Saving settings to the USB flash drive

- 1** Disconnect the power cord from the projector, and check that all of the projector's indicators have turned off.
- 2** Connect the USB flash drive to the projector's USB-A port.

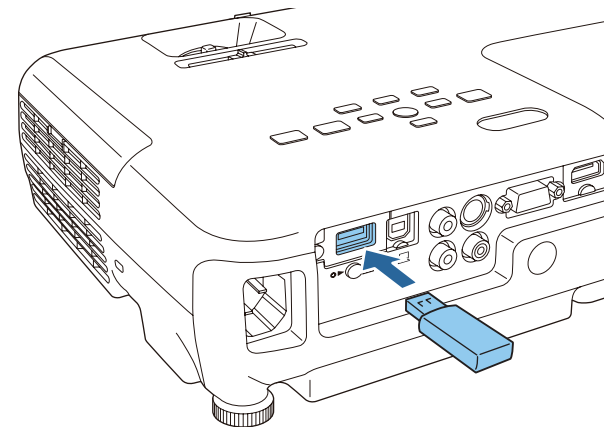



- Connect the USB flash drive directly to the projector. If the USB flash drive is connected to the projector through a USB hub, the settings may not be saved correctly.
- Connect an empty USB flash drive. If the USB flash drive contains data other than the batch setup file, the settings may not be saved correctly.
- If you have saved a batch setup file from another projector to the USB flash drive, delete the file or change the file name. The batch setup function cannot overwrite a batch setup file.
- The file name for the batch setup file is PJCONFDATA.bin. If you need to change the file name, add text after PJCONFDATA. If you change the PJCONFDATA section of the file name, the projector may not be able to recognize the file correctly.
- You can only use single-byte characters for the file name.

- 3** While holding down the [Esc] button on the remote control or the control panel, connect the power cord to the projector.

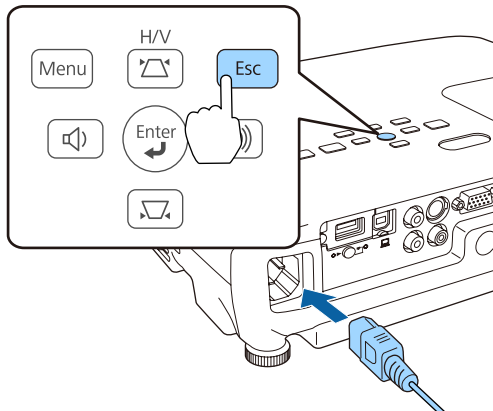

When the projector's indicators turn on as follows, release the [Esc] button.

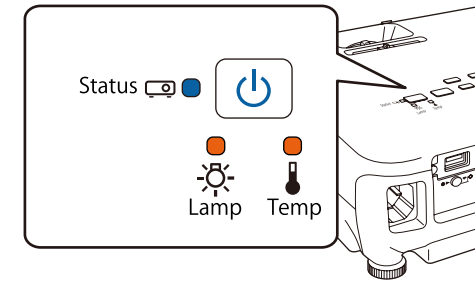

Power: Blue - On / Status: Blue - On / Lamp: Orange - On / Temp: Orange - On

When all of the indicators start flashing, the batch setup file is being written.

Caution

- Do not disconnect the power cord from the projector while the file is being written. If the power cord is disconnected, the projector may not start correctly.
- Do not disconnect the USB flash drive from the projector while the file is being written. If the USB flash drive is disconnected, the projector may not start correctly.

When writing completes normally, the projector enters standby status.

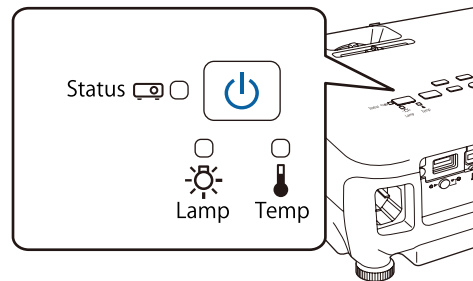

Power: Blue - On

When the projector is in standby status, remove the USB flash drive.

Reflecting saved settings to other projectors

- 1** Disconnect the power cord from the projector, and check that all of the projector's indicators have turned off.
- 2** Connect the USB flash drive containing the saved batch setup file to the projector's USB-A port.

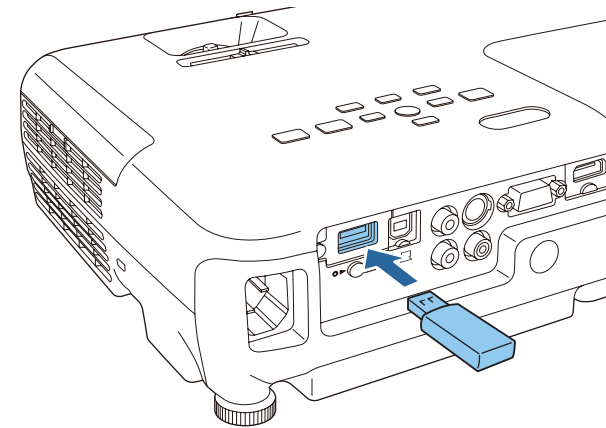

- When the USB flash drive contains 1 to 3 types of batch setup files, the file is reflected to the projector with the same model number. If there are multiple files for a projector with the same model number, the settings may not be reflected correctly.
- When there are four or more types of batch setup files on the USB flash drive, the settings may not be reflected correctly.
- Do not store any data except for the batch setup file on the USB flash drive. If the USB flash drive contains data other than the batch setup file, the settings may not be reflected correctly.

- 3** While holding down the [Menu] button on the remote control or the control panel, connect the power cord to the projector.

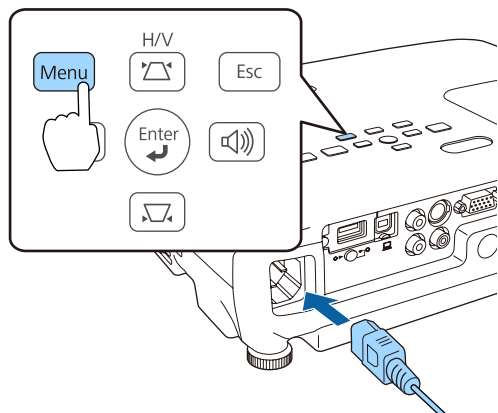

When the projector's indicators turn on as follows, release the [Menu] button.

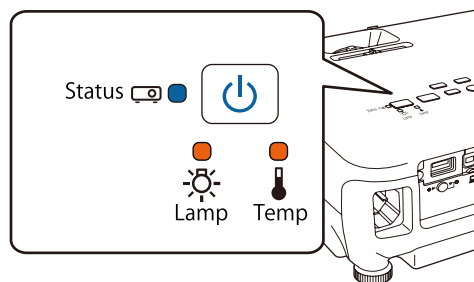

Power: Blue - On / Status: Blue - On / Lamp: Orange - On / Temp: Orange - On

The indicators remain on for about 75 seconds.

When all of the indicators start flashing, the settings are being written.

Caution

- Do not disconnect the power cord from the projector while the settings are being written. If the power cord is disconnected, the projector may not start correctly.
- Do not disconnect the USB flash drive from the projector while the settings are being written. If the USB flash drive is disconnected, the projector may not start correctly.

- 4** When writing completes normally, the projector enters standby status.

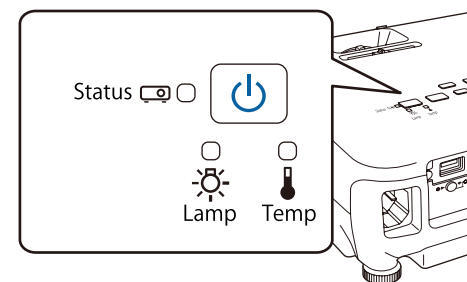

Power: Blue - On

When the projector is in standby status, remove the USB flash drive.

Setup by Connecting the Computer and Projector with a USB Cable



The following operating systems support the batch setup function.

- Windows Vista or later
- Mac OS X 10.5.3 or later

Saving settings to a computer

- 1 Disconnect the power cord from the projector, and check that all of the projector's indicators have turned off.
- 2 Connect the computer's USB port to the projector's USB-B port with a USB cable.

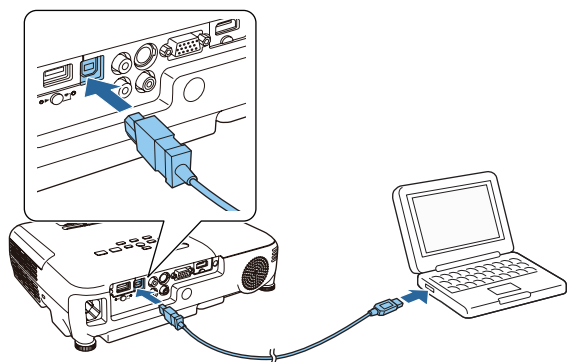

- 3 While holding down the [Esc] button on the remote control or the control panel, connect the power cord to the projector.

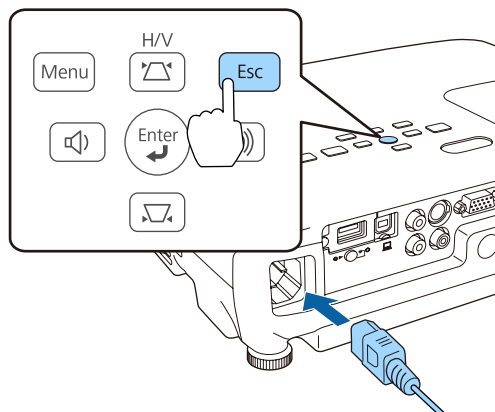

When the projector's indicators turn on as follows, release the [Esc] button.

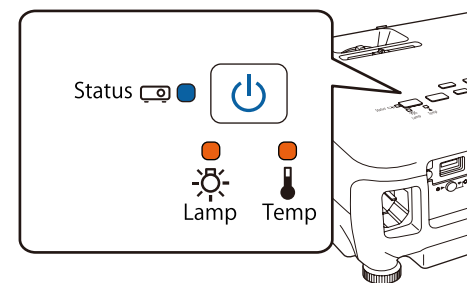

Power: Blue - On / Status: Blue - On / Lamp: Orange - On / Temp: Orange - On

The projector is recognized as a removable disk by the computer.

- 4 Open the removable disk, and save the batch setup file (PJCONFDATA.bin) to the computer.



If you need to change the name of the batch setup file, add text after PJCONFDATA. If you change the PJCONFDATA section of the file name, the projector may not be able to recognize the file correctly.

- 5 Perform "Remove USB device" on your computer, and then disconnect the USB cable.



When using OS X, perform "Remove EPSON_PJ".

The projector enters standby status.

Reflecting saved settings to other projectors

- 1** Disconnect the power cord from the projector, and check that all of the projector's indicators have turned off.
- 2** Connect the computer's USB port to the projector's USB-B port with a USB cable.

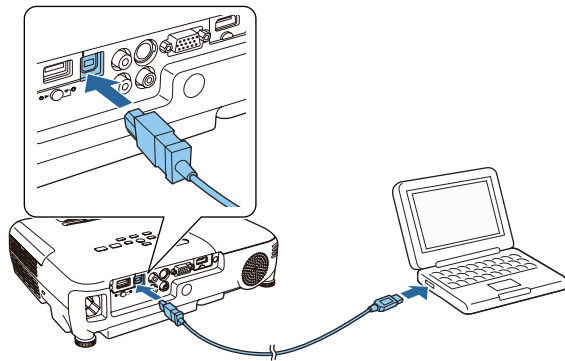

- 3** While holding down the [Menu] button on the remote control or the control panel, connect the power cord to the projector.

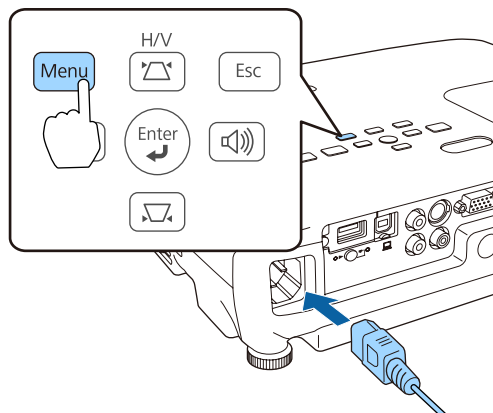

When the projector's indicators turn on as follows, release the [Menu] button.

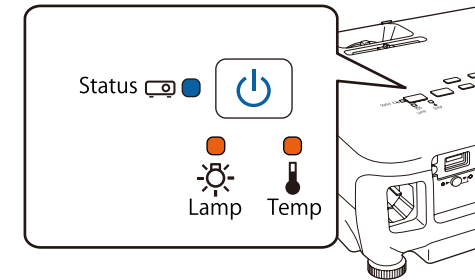

Power: Blue - On / Status: Blue - On / Lamp: Orange - On / Temp: Orange - On

The projector is recognized as a removable disk by the computer.

- 4 Copy the batch setup file (PJCONFDATA.bin) that you saved to your computer to the top level folder of the removable disk.



Do not copy any files or folders other than the batch setup file to the removable disk.

- 5 Perform "Remove USB device" on your computer, and then disconnect the USB cable.



When using OS X, perform "Remove EPSON_PJ".

When all of the indicators start flashing, the settings are being written.



Caution

Do not disconnect the power cord from the projector while the settings are being written. If the power cord is disconnected, the projector may not start correctly.

When writing completes normally, the projector enters standby status.

When Setup Fails

The indicators notify you if an error occurs. Check the status of the indicators.

Status of the Indicators	Remedy
Status Lamp: Orange - flashing fast Temp: Orange - flashing fast	The batch setup file may be corrupt, or the USB flash drive or USB cable may not be connected correctly. Disconnect the USB flash drive or the USB cable, unplug and then plug in the projector's power cord, and then try again.
Status Power: Blue - flashing fast Status: Blue - flashing fast Lamp: Orange - flashing fast Temp: Orange - flashing fast	Writing the settings may have failed and an error may have occurred in the projector's firmware. Stop using the projector, remove the power plug from the electrical outlet, and contact your local dealer or the nearest address provided in the Epson Projector Contact List.



Troubleshooting

This chapter explains how to identify problems and what to do if a problem is found.

If a problem occurs with the projector, the Help screen is displayed to assist you by pressing the Help button. You can solve problems by answering the questions.

- 1 Press the [Help] button.
The Help screen is displayed.

Using the remote control

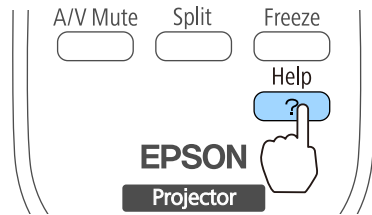

Using the control panel

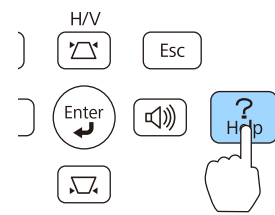

- 2 Select a menu item.

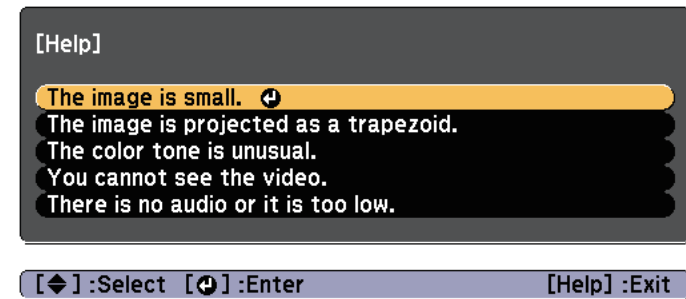

Using the remote control

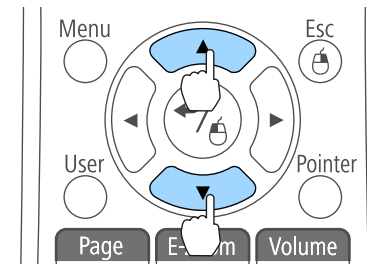

Using the control panel

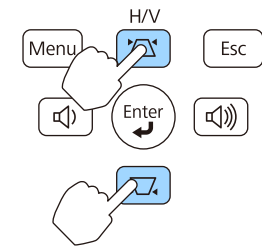

- 3 Confirm the selection.

Using the remote control

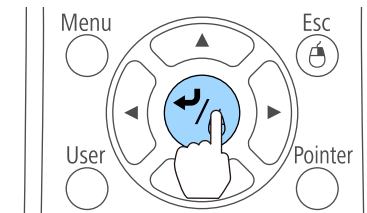

Using the control panel

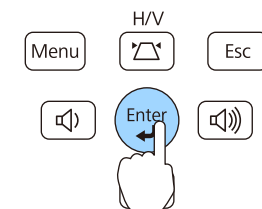

Questions and solutions are displayed as shown on the screen below. Press the [Help] button to exit the Help.

The image is small.

- ❓ Is zoom set to minimum?
· Use the zoom ring to change the size of the image.
- ❓ Is the projector too close to the screen?
· Move the projector away from the screen.

[Esc] :Return

[Help] :Exit



See the following if the Help function does not provide a solution to the problem.

☞ "Problem Solving" [p.110](#)

If you are having a problem with the projector, first check the projector's indicators and refer to "Reading the Indicators" below.

See the following if the indicators do not show clearly what the problem might be.



☛ "When the Indicators Provide No Help" [p.114](#)



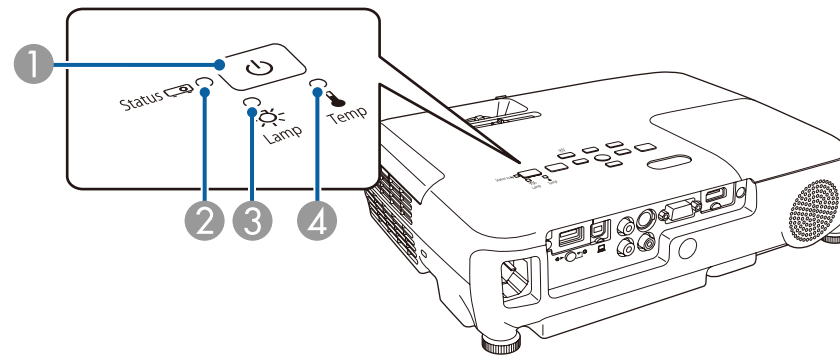

Reading the Indicators

The projector is provided with the following four indicators. The color and lit status of the indicators shows the status of the projector.



- | | |
|--------------------|--|
| ① Power indicator | Indicates the projector's status. |
| ② Status indicator | Indicates the projector's status. |
| ③ Lamp indicator | Indicates the projection lamp status. |
| ④ Temp indicator | Indicates the internal temperature status. |

















Indicators		Status	Explanation
Power supply	Status		
 Blue - Lit	<input type="checkbox"/> Off	Standby condition	Power is being supplied to the projector. When the [⏻] power button is pressed in this condition, projection starts.
		Network monitoring status	The projector is being monitored and controlled over a network (when Standby Mode is set to Communication On). If the power cord is disconnected and connected in this status, the power indicator flashes blue.
 Blue - Lit	 Blue - Flashing	Warm-up status	This is the status immediately after turning on the projector. Warm-up takes approximately 30 seconds after the lamp turns on. In this status you cannot turn off the projector, even if you press the [⏻] power button.

























Indicators		Status	Explanation
Power supply	Status		
 Blue - Lit	 Blue - Flashing	Cool down status	This is the status immediately after turning off the projector. In this status, all buttons are disabled.
 Blue - Lit	 Blue - Lit	Normal status	The projector is projecting.





Refer to the following table to see what the indicators mean and how to remedy problems that they indicate.

If all indicators are off, check that the power cord is connected correctly and that the power is being supplied normally.



Sometimes, when the power cord is unplugged, the [⏻] power indicator remains lit for a short period, but this is not a fault.

Indicators				Cause	Remedy or Status
Power supply	Status	Lamp	Temperature		
 Off	 Blue - Flashing	 Orange - Flashing	 Off	Internal Error	Stop using the projector, remove the power plug from the electrical outlet, and contact your local dealer or the nearest address provided in the Epson Projector Contact List.  Epson Projector Contact List
 Off	 Blue - Flashing	 Off	 Orange - Flashing	Fan Error Sensor Error	Stop using the projector, remove the power plug from the electrical outlet, and contact your local dealer or the nearest address provided in the Epson Projector Contact List.  Epson Projector Contact List
 Off	 Blue - Flashing	 Off	 Orange - Lit	High Temp Error (Overheating)	<p>The lamp turns off automatically and projection stops. Wait for about five minutes. After about five minutes the projector switches to standby mode, so check the following two points.</p> <ul style="list-style-type: none"> • Check that the air filter and air exhaust vent are clear, and that the projector is not positioned against a wall. • If the air filter is clogged, clean or replace it.  "Cleaning the Air Filter" p.126, "Replacing the Air Filter" p.131 <p>If the error continues after checking the points above, stop using the projector, remove the power plug from the electrical outlet, and contact your local dealer or the nearest address provided in the Epson Projector Contact List.  Epson Projector Contact List</p>
					<p>When using at an altitude of 1500 m or more, set High Altitude Mode to On.  "Extended Menu" p.89</p>

Indicators				Cause	Remedy or Status
Power supply	Status	Lamp	Temperature		
 Off	 Blue - Flashing	 Orange - Lit	 Off	Lamp Error Lamp Failure	Check the following two points. <ul style="list-style-type: none"> Take out the lamp and check if it is cracked.  "Replacing the Lamp" p.128 Clean the air filter.  "Cleaning the Air Filter" p.126 <p>If the lamp is not cracked: Reinstall the lamp and plug in the power cord.</p> <p>If the error continues: Stop using the projector, remove the power plug from the electrical outlet, and contact your local dealer or the nearest address provided in the Epson Projector Contact List.  Epson Projector Contact List</p> <p>If the lamp is cracked: Contact your local dealer or the nearest address provided in the Epson Projector Contact List. (Images cannot be projected until the lamp is replaced.)  Epson Projector Contact List</p> <p>When using at an altitude of 1500 m or more, set High Altitude Mode to On.  "Extended Menu" p.89</p>
				Lamp Cover Open	Check that the lamp and the lamp cover are securely installed. The lamp does not turn on if the lamp and the lamp cover are not installed correctly.  "Replacing the Lamp" p.128
 Off	 Blue - Flashing	 Orange - Flashing	 Orange - Flashing	Auto Iris Error	Stop using the projector, remove the power plug from the electrical outlet, and contact your local dealer or the nearest address provided in the Epson Projector Contact List.  Epson Projector Contact List
 Off	 Blue - Flashing	 Orange - Lit	 Orange - Lit	Power Err.	
 Blue - Flashing	 State dependant indication	 State dependant indication	 Orange - Flashing	High Temp Warning	(This is not an abnormality. However, if the temperature rises too high again, projection stops automatically.) <ul style="list-style-type: none"> Check that the air filter and air exhaust vent are clear, and that the projector is not positioned against a wall. If the air filter is clogged, clean or replace it.  "Cleaning the Air Filter" p.126, "Replacing the Air Filter" p.131

Indicators				Cause	Remedy or Status
Power supply	Status	Lamp	Temperature		
 Blue - Flashing	 State dependant indication	 Orange - Flashing	 State dependant indication	Replace Lamp	Replace it with a new lamp.  "Replacing the Lamp" p.128 If you continue to use the lamp after the replacement period has passed, the possibility that the lamp may explode increases. Replace it with a new lamp as soon as possible.



- See the following if the projector is not operating properly, even though the indicators are all showing normal.
 -  "When the Indicators Provide No Help" [p.114](#)
- If the indicators are in a state not shown in this table, stop using the projector, remove the power plug from the electrical outlet, and contact your local dealer or the nearest address provided in the Epson Projector Contact List.
 -  [Epson Projector Contact List](#)

When the Indicators Provide No Help

If any of the following problems occur and the indicators do not offer a solution, refer to the pages given for each problem.

Problems Relating to Images

<ul style="list-style-type: none"> • No images appear Projection does not start, the projection area is completely black, or the projection area is completely blue. 	☞ p.115
<ul style="list-style-type: none"> • Moving images are not displayed Moving images being projected from a computer appear black and nothing is projected, or no moving images are played back on the computer. 	☞ p.116
<ul style="list-style-type: none"> • Projection stops automatically 	☞ p.116
<ul style="list-style-type: none"> • The message "Not supported" is displayed 	☞ p.116
<ul style="list-style-type: none"> • The message "No Signal" is displayed 	☞ p.117
<ul style="list-style-type: none"> • Cannot view 3D images 	☞ p.117
<ul style="list-style-type: none"> • Images are fuzzy, out of focus, or distorted 	☞ p.118
<ul style="list-style-type: none"> • Interference or distortion appear in images 	☞ p.118
<ul style="list-style-type: none"> • The image is truncated (large) or small, the aspect ratio is not suitable, or the image has been reversed Only part of the image is displayed, the height and width ratios of the image are not correct, or the image may appear reversed from top to bottom or left to right. 	☞ p.119
<ul style="list-style-type: none"> • Image colors are not right The whole image appears purplish or greenish, images are black & white, or colors appear dull. 	☞ p.120
<ul style="list-style-type: none"> • Images appear dark 	☞ p.121

Problems when projection starts

<ul style="list-style-type: none"> • The projector does not turn on 	☞ p.121
---	-------------------------

Other Problems

<ul style="list-style-type: none"> • No sound can be heard or the sound is faint 	☞ p.122
<ul style="list-style-type: none"> • There is noise in the audio (only when projecting USB display) 	☞ p.122
<ul style="list-style-type: none"> • The remote control does not work 	☞ p.123
<ul style="list-style-type: none"> • I want to change the language for messages and menus 	☞ p.123
<ul style="list-style-type: none"> • Mail is not received even if a problem occurs in the projector 	☞ p.123
<ul style="list-style-type: none"> • Cannot change settings using a Web browser 	☞ p.124

Problems Relating to Images

No images appear

Check	Remedy
Did you press the [⏻] power button?	Press the [⏻] power button to turn the power on.
Are the indicators switched off?	The power cord is not connected correctly or power is not being supplied. Connect the projector's power cord correctly. ☛ "From Installation to Projection" p.32 Check that your electrical outlet or power source is functioning correctly.
Is A/V Mute active?	Press the [A/V Mute] button on the remote control to cancel A/V Mute. ☛ "Hiding the Image and Sound Temporarily (A/V Mute)" p.65
Is the A/V mute slide closed?	No images are displayed if the lens cover is closed even a little. Open the lens cover completely. ☛ "Front/Top" p.11
Are the Configuration menu settings correct?	Reset all of the settings. ☛ Reset - Reset All p.99 When using USB Display, set USB Type B to USB Display . ☛ Extended - USB Type B p.89
Is the image to be projected completely black? (Only when projecting computer images)	Some input images, such as screen savers, may be completely black.
Is the image signal format setting correct? (Only when projecting images from a video source)	Change the setting according to the signal for the connected equipment. ☛ Signal - Video Signal p.85
Is the USB cable connected correctly? (Only when projecting USB Display)	Check that the USB cable is connected correctly. Reconnect it if it is not connected or not connected properly.
Is Windows Media Center displayed in full screen? (Only when projecting using USB Display or network connection)	When Windows Media Center is displayed at full screen, you cannot project using USB Display or network connection. Reduce the screen size.
Is an application using the Windows DirectX function displayed? (Only when projecting using USB Display or network connection)	Applications using the Windows DirectX function may not display images correctly.

Moving images are not displayed

Check	Remedy
Is the computer's image signal being output to the LCD and the monitor? (Only when projecting images from a laptop computer or a computer with a built-in LCD screen)	Change the image signal from the computer to external output only. Check your computer's documentation, or contact the computer's manufacturer.
Are the contents of the moving image you are trying to project copyright protected?	The projector may not be able to project copyright protected moving images that are being played back on a computer. For more details, see the user's guide supplied with the player.

Projection stops automatically

Check	Remedy
Are Sleep Mode , Lens Cover Timer , or A/V Mute Timer set to On ?	If any of these are set to On , the power turns off automatically in the following situations. <ul style="list-style-type: none"> • When Sleep Mode is set to On: If no operations are performed for a specified length of time while no image signal is being input. • When Lens Cover Timer is set to On: If approximately 30 minutes has passed since the lens cover was closed. • When A/V Mute Timer is set to On: If approximately 30 minutes has passed since the A/V mute was enabled. To prevent the projector from switching off automatically, make sure each setting is set to Off . ☛ "ECO Menu" p.97
Is the computer in power-saving mode?	If the computer is in power-saving mode and no operations are performed for a specified period of time, the image may disappear. Perform an operation on the computer to display the image again.

The message "Not supported" is displayed

Check	Remedy
Is the image signal format setting correct? (Only when projecting images from a video source)	Change the setting according to the signal for the connected equipment. ☛ Signal - Video Signal p.85
Do the image signal resolution and the refresh rate correspond to the mode? (Only when projecting computer images)	Refer to the computer's documentation for how to change the image signal resolution and the refresh rate output from the computer. ☛ "Supported Monitor Displays" p.138

The message "No Signal" is displayed

Check	Remedy
Are the cables connected correctly?	Check that all the cables required for projection are securely connected. ☛ "From Installation to Projection" p.32
Is the correct port selected?	Change the image by pressing the [Source Search] button on the remote control or the control panel. ☛ "Automatically Detect Input Signals and Change the Projected Image (Source Search)" p.33
Is the power for the computer or video source turned on?	Turn the power on for the equipment.
Are the image signals being output to the projector? (Only when projecting images from a laptop computer or a computer with a built-in LCD screen)	If the image signals are only being output to the computer's LCD monitor or to the accessory monitor, you need to change the output to an external destination as well as the computer's own monitor. For some computer models, when the image signals are output externally, they no longer appear on the LCD monitor or accessory monitor. If the connection is made while the power of the projector or computer is already turned on, the Fn key (Function key) that changes the computer's image signal to external output may not work. Turn the power for the computer and the projector off and then back on again. ☛ "From Installation to Projection" p.32 ☛ Computer's documentation
Is the computer in power-saving mode?	If the computer is in power-saving mode and no operations are performed for a specified period of time, the image may disappear. Perform an operation on the computer to display the image again.

Cannot view 3D images

Check	Remedy
Is the Configuration menu set correctly?	<ul style="list-style-type: none"> • Set 3D Display to On. • Set 3D Format to Auto or the same format as the 3D signal from the connected device. ☛ Signal - 3D Setup p.85
Is the input signal a 3D signal?	Check that the connected playback device and the content being played support 3D signals.
Are you wearing the 3D Glasses correctly?	To view 3D images with this projector, you need active shutter 3D glasses. Use the optional active 3D Glasses (ELPGS03). ☛ "Optional Accessories" p.134
Are the 3D Glasses turned on?	Turn on the 3D Glasses. Also, when you turn on the power for the first time, you need to perform pairing. ☛ "Registering the 3D Glasses to the projector (pairing)" p.52
Are you viewing within the 3D image viewing area?	The range for viewing 3D images is up to 10 meters from the projector. Make sure you view within the viewing range. ☛ "Viewing area for 3D images" p.54

Check	Remedy
Are there any devices that cause radio wave interference in the vicinity?	When using other devices at the same time with the frequency band (2.4 GHz) such as Bluetooth communication devices, wireless LAN (IEEE802.11b/g), or microwave ovens, radio wave interference may occur, or the image may be interrupted. Do not use the projector near these devices.

Images are fuzzy, out of focus, or distorted

Check	Remedy
Is Auto V-Keystone set to Off ?	Setting it to On enables Auto V-Keystone. ☛ Settings - Keystone - H/V-Keystone - Auto V-Keystone p.88 If you are using the projector with this setting off, manually adjust the projected image. ☛ "Correcting manually" p.39
Is the focus adjusted correctly?	Turn the focus ring to adjust the focus. ☛ "Correcting the Focus" p.43
Is the projector at the correct distance?	Is it projecting outside of the recommended projection distance range? Setup within the recommended range. ☛ "Screen Size and Projection Distance" p.136
Is the Keystone adjustment value too large?	Lower the projection angle to reduce the amount of Keystone correction. ☛ "Adjusting the Image Position" p.42
Has condensation formed on the lens?	If the projector is suddenly taken from a cold environment to a warm environment, or if sudden ambient temperature changes occur, condensation may form on the surface of the lens, and this may cause the images to appear fuzzy. Set the projector up in the room about one hour before it is used. If condensation forms on the lens, turn the projector off and wait for the condensation to disappear.

Interference or distortion appear in images

Check	Remedy
Is the image signal format setting correct? (Only when projecting images from a video source)	Change the setting according to the signal for the connected equipment. ☛ Signal - Video Signal p.85
Are the cables connected correctly?	Check that all the cables required for projection are securely connected. ☛ "Connecting Equipment" p.23

Check	Remedy
Is an extension cable being used?	If an extension cable is used, electrical interference may affect the signals. Use the cables supplied with the projector to check if the cables you are using may be causing the problem.
Is the correct resolution selected? (Only when projecting computer images)	Set the computer so that the signals being output are compatible with the projector. ☛ "Supported Monitor Displays" p.138 ☛ Computer's documentation
Are the Sync and Tracking settings adjusted correctly? (Only when projecting computer images)	Press the [Auto] button on the remote control or the [↶] button on the control panel to perform automatic adjustment. If the images are not adjusted correctly even after performing automatic adjustment, you can also make adjustments from the Configuration menu. ☛ Signal - Tracking, Sync. p.85
Is Transfer layered window selected? (Only when projecting USB Display)	Click All Programs - EPSON Projector - Epson USB Display - Epson USB Display Vx.xx Settings , and then clear the Transfer layered window check box.
The mouse cursor flickers (only when projecting USB Display)	Is Make the movement of the mouse pointer smooth. selected? Click All Programs - EPSON Projector - Epson USB Display - Epson USB Display Vx.xx Settings , and then select Make the movement of the mouse pointer smooth. (This is not available for Windows 2000.) For Windows Vista/7, Windows Aero is disabled when this is selected.

The image is truncated (large) or small, the aspect is not suitable, or the image has been reversed

Check	Remedy
Is a wide panel computer image being projected? (Only when projecting computer images)	Change the setting according to the signal for the connected equipment. ☛ Signal - Resolution p.85
Is the image still being enlarged by E-Zoom?	Press the [Esc] button on the remote control to cancel E-Zoom. ☛ "Enlarging Part of the Image (E-Zoom)" p.67
Is the image position adjusted correctly?	Press the [Auto] button on the remote control or the [↶] button on the control panel to adjust the position. You can only adjust the display position from the Configuration menu. ☛ Signal - Position p.85
Is the computer set for dual display? (Only when projecting computer images)	If dual display is activated in the Display Properties of the computer's Control Panel, only about half of the image on the computer screen is projected. To display the entire image on the computer screen, turn off the dual display setting. ☛ Computer video driver documentation

Check	Remedy
Is the correct resolution selected? (Only when projecting computer images)	Set the computer so that the signals being output are compatible with the projector. <ul style="list-style-type: none"> ☛ "Supported Monitor Displays" p.138 ☛ Computer's documentation
Is the projection mode correct?	Depending on how the projector is installed, set the projection mode from one of the following: Front, Front/Ceiling, Rear, Rear/Ceiling. <ul style="list-style-type: none"> ☛ Extended - Projection p.89 ☛ "Installation Methods" p.21

Image colors are not right

Check	Remedy
Do the input signal settings match the signals from the connected device?	Change the following settings according to the signal for the connected equipment. <ul style="list-style-type: none"> • When the image is from a device connected to the Computer port <ul style="list-style-type: none"> ☛ Signal - Input Signal p.85 • When the image is from a device connected to the Video or S-Video port. <ul style="list-style-type: none"> ☛ Signal - Video Signal p.85
Is the image brightness adjusted correctly?	Adjust the Brightness setting from the Configuration menu. ☛ Image - Brightness p.85
Are the cables connected correctly?	Check that all the cables required for projection are securely connected. Check that no cables are disconnected and that there are no poor contacts in the cables. ☛ "Connecting Equipment" p.23
Is the <u>contrast</u>  adjusted correctly?	Adjust the Contrast setting from the Configuration menu. ☛ Image - Contrast p.85
Is the color adjustment set correctly?	Adjust the Color Adjustment setting from the Configuration menu. ☛ Image - Color Adjustment p.85
Are the color saturation and tint adjusted correctly? (Only when projecting images from a video source)	Adjust the Color Saturation and Tint settings from the Configuration menu. ☛ Image - Color Saturation, Tint p.85

Images appear dark

Check	Remedy
Is the image brightness set correctly?	Adjust the Brightness and Power Consumption settings from the Configuration menu. ☛ Image - Brightness p.85 ☛ ECO - Power Consumption p.97
Is the <u>contrast</u> adjusted correctly?	Adjust the Contrast setting from the Configuration menu. ☛ Image - Contrast p.85
Is it time to replace the lamp?	When the lamp is nearly ready for replacement, the images become darker and the color quality becomes poorer. When this happens, replace the lamp with a new lamp. ☛ "Replacing the Lamp" p.128
Are you using the projector at a high altitude or in a location subject to high temperatures?	The screen may become dark when using at high altitude or in a location subject to high temperatures. Although you cannot make Power Consumption settings at this time, you can continue to use the projector.
Is it projecting outside of the recommended projection distance range?	The image becomes darker if the projection distance is too large. Setup within the recommended range. ☛ "Screen Size and Projection Distance" p.136

Problems when Projection Starts

The projector does not turn on

Check	Remedy
Did you press the [⏻] power button?	Press the [⏻] power button to turn the power on.
Are the indicators switched off?	The power cord is not connected correctly or power is not being fully supplied. Disconnect and then reconnect the power cord. ☛ "From Installation to Projection" p.32 Check that your electrical outlet or power source is functioning correctly.
Do the indicators turn on and off when the power cord is touched?	There is probably a poor contact in the power cord, or the power cord may be defective. Reinsert the power cord. If this does not solve the problem, stop using the projector, disconnect the power cord from the electrical outlet, and contact your local dealer or the nearest address provided in the Epson Projector Contact List. ☛ <i>Epson Projector Contact List</i>

Check	Remedy
Is the Control Panel Lock set to Full Lock ?	Press the [⏻] power button on the remote control. If you do not want to use Control Panel Lock , change the setting to Off . 🖱️ Settings - Control Panel Lock p.88
Is remote control operation restricted?	Check the Remote Receiver from the Configuration menu. 🖱️ Settings - Remote Receiver p.88

Other Problems

No sound can be heard or the sound is faint

Check	Remedy
Check that the audio/video cable is securely attached to both the projector and audio source.	Disconnect the cable from the Audio port, and then reconnect the cable.
Is the volume for the projector or the connected equipment set to the minimum?	Adjust the volume so that sound can be heard. 🖱️ Settings - Volume p.88 🖱️ "Adjusting the Volume" p.43
Is A/V Mute active?	Press the [A/V Mute] button on the remote control to cancel A/V Mute. 🖱️ "Hiding the Image and Sound Temporarily (A/V Mute)" p.65
Is the audio cable's specification "No resistance"?	When using a commercially available audio cable, make sure it is labeled "No resistance".
Is it connected with an HDMI cable?	If no audio is output when connecting via an HDMI cable, set the connected equipment to PCM output.
Is Output audio from the projector selected? (Only when projecting USB Display)	Click All Programs - EPSON Projector - Epson USB Display - Epson USB Display Vx.xx Settings , and then select Output audio from the projector .

There is noise in the audio (only when projecting USB display)

Check	Remedy
Is the volume for the computer set to the minimum while the projector is set to the maximum?	If the volume for the computer is set to the minimum while the projector is set to the maximum, the noise may be mixed. Turn up the computer's volume and turn down the projector's volume.

The remote control does not work

Check	Remedy
Is the remote control light-emitting area pointing towards the remote receiver on the projector during operation?	Point the remote control towards the remote receiver. ☛ "Remote control operating range" p.19
Is the remote control too far from the projector?	The operating range for the remote control is about six meters. ☛ "Remote control operating range" p.19
Is direct sunlight or strong light from fluorescent lamps shining onto the remote receiver?	Set the projector up in a location where strong light does not shine onto the remote receiver. ☛ Settings - Remote Receiver p.88
Is the correct setting for the Remote Receiver selected?	Check the Remote Receiver from the Configuration menu. ☛ Settings - Remote Receiver p.88
Are the batteries dead or have the batteries been inserted correctly?	Make sure the batteries are inserted correctly or replace the batteries with new ones if necessary. ☛ "Replacing the remote control batteries" p.18

I want to change the language for messages and menus

Check	Remedy
Change the Language setting.	Adjust the Language setting from the Configuration menu. ☛ Extended - Language p.89

Mail is not received even if a problem occurs in the projector

Check	Remedy
Is Standby Mode set to Communication On ?	To use the Mail Notification function when the projector is in standby, set Communication On in Standby Mode from the Configuration menu. ☛ ECO - Standby Mode p.97
Did a fatal abnormality occur and the projector come to a sudden stop?	If the abnormal state continues, contact your local dealer or the nearest address provided in the Epson Projector Contact List. ☛ Epson Projector Contact List
Is power being supplied to the projector?	Check that your electrical outlet or power source is functioning correctly.

Check	Remedy
Is the Mail Notification function set correctly in the Configuration menu?	An error notification email is sent according to the Mail settings in the Configuration menu. Check if it is set correctly. ☛ "Mail menu" p.95

Cannot change settings using a Web browser

Check	Remedy
Are the user ID and password correct?	Enter "EPSONWEB" as the user ID. This cannot be changed. Enter the user ID even if the password setting is disabled. Enter the characters set for the Web Control Password as the password. The initial password is "admin".



Maintenance

This chapter provides information on maintenance procedures to ensure the best level of performance from the projector for a long time to come.

You should clean the projector if it becomes dirty or if the quality of projected images starts to deteriorate.

Caution

Turn off the projector's power before cleaning. Otherwise, it could cause an electric shock.

Cleaning the Projector's Surface

Clean the projector's surface by wiping it gently with a soft cloth.

If the projector is particularly dirty, moisten the cloth with water containing a small amount of neutral detergent, and then firmly wring the cloth dry before using it to wipe the projector's surface.

Attention

Do not use volatile substances such as wax, alcohol, or thinner to clean the projector's surface. The quality of the case may change or become discolored.

Cleaning the Lens

Use a commercially available cloth for cleaning glasses to gently wipe the lens.

Warning

Do not use sprays that contain flammable gas to remove dust and lint from the lens. The projector may catch fire due to the high internal temperature of the lamp.

Attention

Do not rub the lens with harsh materials or subject the lens to shocks as it can easily become damaged.

Cleaning the 3D Glasses

Clean the lenses of the glasses by wiping them gently with a soft cloth.

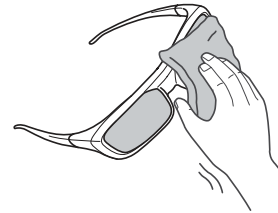

Attention

- Do not rub the lenses of the glasses with harsh materials or handle them too roughly as they can easily become damaged.
- When maintenance is necessary, disconnect the USB Charging Adapter from the electrical outlet, and check that all cables have been disconnected.

Cleaning the Air Filter

Clean the air filter and the air intake vent when the following message is displayed.

"The projector is overheating. Make sure nothing is blocking the air vent, and clean or replace the air filter."

Attention

- If dust collects on the air filter, it can cause the internal temperature of the projector to rise, and this can lead to problems with operation and shorten the optical engine's service life. Clean the air filter immediately when the message is displayed.
- Do not rinse the air filter in water. Do not use detergents or solvents.

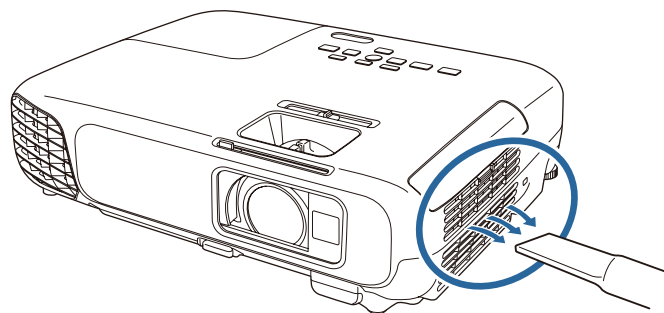

- If a message is frequently displayed, even after cleaning, it is time to replace the air filter. Replace it with a new air filter.
 - ☛ "Replacing the Air Filter" [p.131](#)
- It is recommended that you clean these parts at least once every three months. Clean them more often than this if using the projector in a particularly dusty environment.

This section explains how to replace the lamp and the air filter.

Replacing the Lamp

Lamp replacement period

It is time to replace the lamp when:

- The following message is displayed.
"Time to replace the lamp. Please contact your Epson projector reseller or visit www.epson.com to purchase."

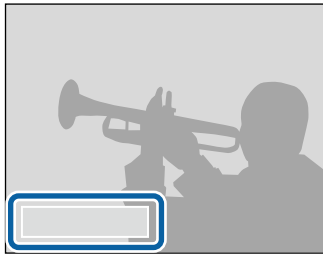

The message is displayed for 30 seconds.

- The power indicator is flashing blue, and the lamp indicator is flashing orange.

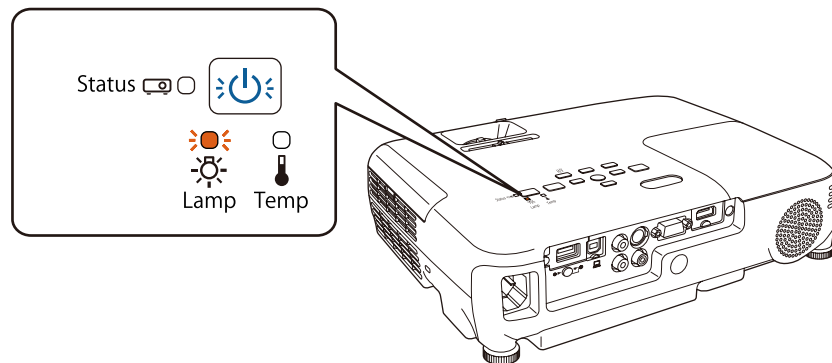

- The projected image gets darker or starts to deteriorate.

Attention

- The lamp replacement message is set to appear after the following time periods in order to maintain the initial brightness and quality of the projected images.
When **Power Consumption** is set to **Normal**: About 4,900 hours
When **Power Consumption** is set to **ECO**: About 5,900 hours
☛ **ECO - Power Consumption** [p.97](#)
- If you continue to use the lamp after the replacement period has passed, the possibility that the lamp may explode increases. When the lamp replacement message appears, replace the lamp with a new one as soon as possible, even if it is still working.
- Do not repeatedly turn off the power and immediately back on. Turning the power on and off frequently may shorten the lamp's operating life.
- Depending on the characteristics of the lamp and the way it has been used, the lamp may become darker or stop working before the lamp warning message appears. You should always have a spare lamp unit ready in case it is needed.
- We recommend the use of genuine EPSON option lamps. The use of non-genuine lamps may affect projection quality and safety. Any damage or malfunction caused by the use of non-genuine lamps may not be covered by Epson's warranty.

How to replace the lamp

The lamp can be replaced even when the projector is suspended from a ceiling.

Warning

- When replacing the lamp because it has stopped illuminating, there is a possibility that the lamp may be broken. If replacing the lamp of a projector which has been installed on the ceiling, you should always assume that the lamp is cracked, and you should stand to the side of the lamp cover, not underneath it. Remove the lamp cover gently. Be careful when removing the lamp cover as shards of glass may fall out and could cause an injury. If any shards of glass get into your eyes or mouth, contact your local physician immediately.
- Never disassemble or remodel the lamp. If a modified or disassembled lamp is installed in the projector and used, it could cause a fire, electric shock, or an accident.

Caution

Wait until the lamp has cooled down sufficiently before removing the lamp cover. If the lamp is still hot, burns or other injuries may result. It takes about one hour after the power has been turned off for the lamp to be cool enough.

- 1** After you turn off the projector's power and the confirmation buzzer beeps twice, disconnect the power cord.
- 2** Wait until the lamp has sufficiently cooled down, and then remove the lamp cover at the top of the projector.
Loosen the Lamp cover fixing screw with the screwdriver supplied with the new lamp unit or a cross-head screwdriver. Then slide the lamp cover straight forward and lift it to remove.

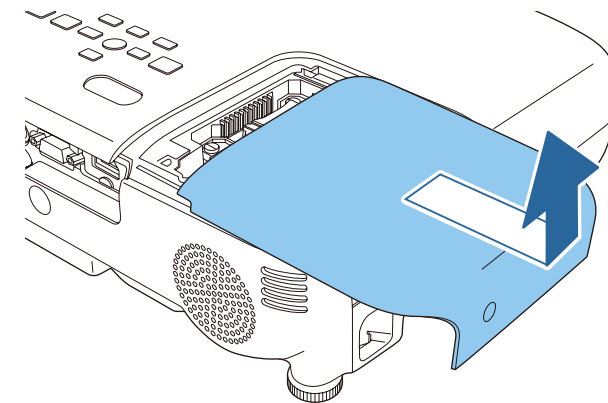
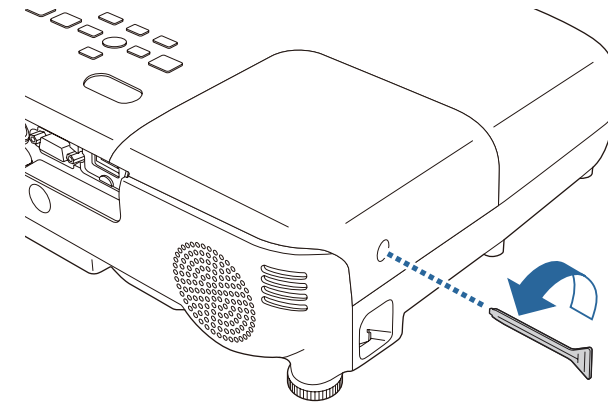

- 3** Loosen the two lamp fixing screws.

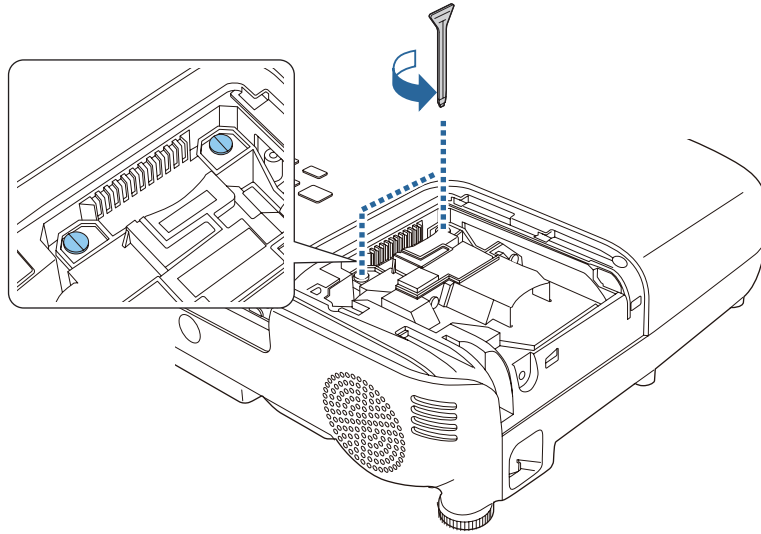

- 4** Grip the raised section of the old lamp and remove it.
If the Lamp is cracked, replace it with a new lamp, or contact your local dealer for further advice.

 [Epson Projector Contact List](#)

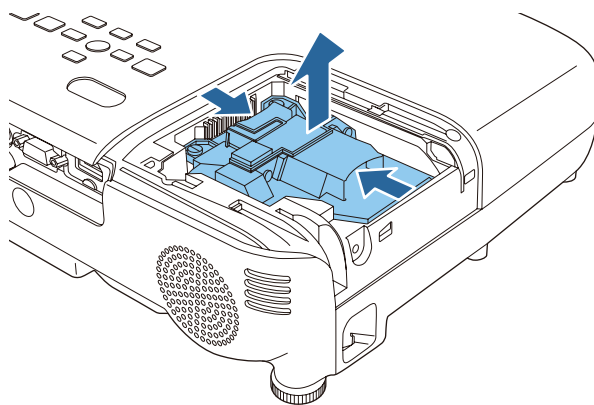

- 5** Install the new lamp.
Insert the new Lamp along the guide rail in the correct direction so that it fits in place, push in firmly, and once it is fully inserted tighten the two screws.

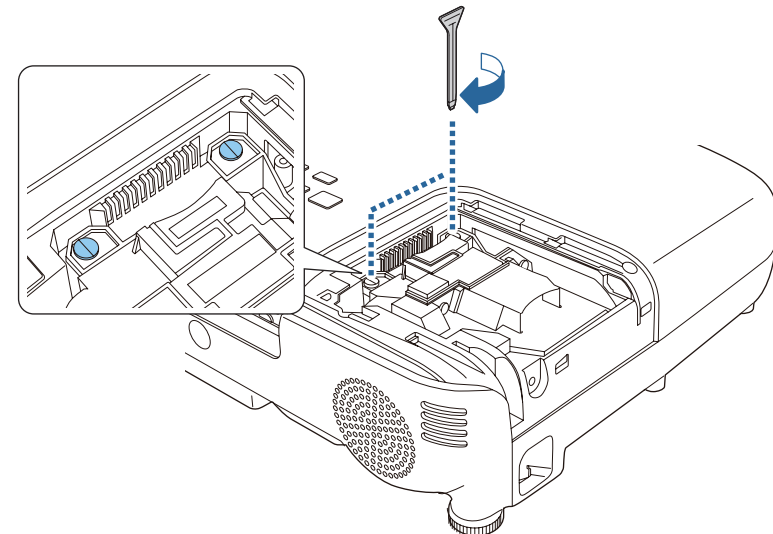
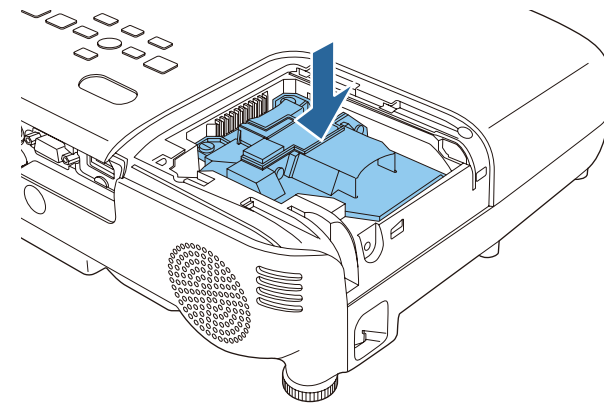

6 Replace the lamp cover.

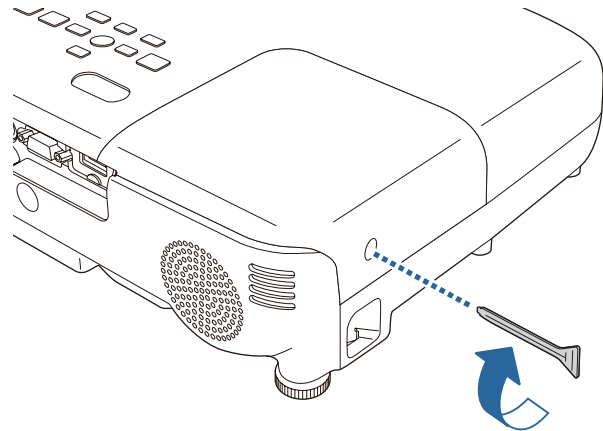

Attention

- Make sure you install the lamp securely. If the lamp cover is removed, the lamps turn off automatically as a safety precaution. If the lamp or the lamp cover is not installed correctly, the lamp will not turn on.
- This product includes a lamp component that contains mercury (Hg). Please consult your local regulations regarding disposal or recycling. Do not dispose of it with normal waste.

Resetting the lamp hours

The projector records how long the lamp is turned on and a message and indicator notify you when it is time to replace the lamp. After replacing the lamp, make sure you reset the Lamp Hours from the Reset menu.

☛ **Reset - Reset Lamp Hours** [p.99](#)



Only reset the **Lamp Hours** after the lamp has been replaced. Otherwise the lamp replacement period is not indicated correctly.

Replacing the Air Filter

Air filter replacement period

If the message is displayed frequently even though the air filter has been cleaned, replace the air filter.

How to replace the air filter

The air filter can be replaced even when the projector is suspended from a ceiling.

- 1 After you turn off the projector's power and the confirmation buzzer beeps twice, disconnect the power cord.
- 2 Open the air filter cover.

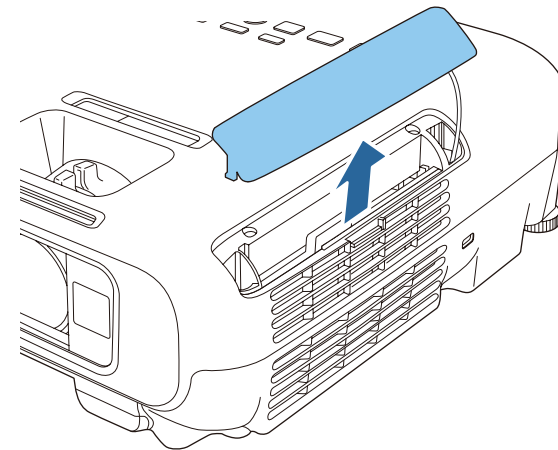

- 3 Remove the air filter.
Grip the air filter cover tab and pull it straight out.

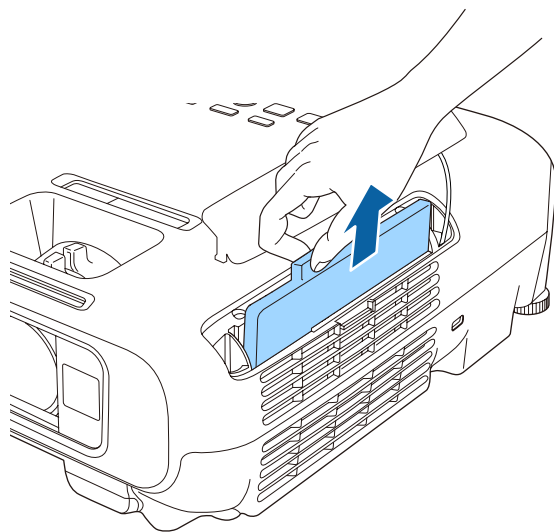

4 Install the new air filter.

Slide the air filter from the outside and press in until it firmly clicks into place.

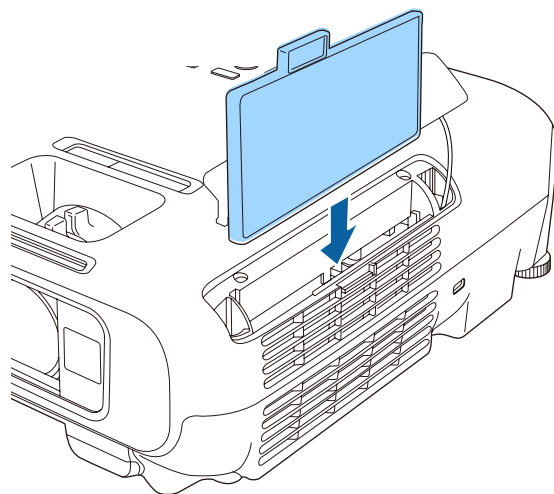

5 Close the air filter cover.



Dispose of used air filters properly in accordance with your local regulations.

Filter frame: ABS

Filter: Polyurethane foam



Appendix

The following optional accessories and consumables are available. Please purchase these products as and when needed. The following list of optional accessories and consumables is current as of: May 2014. Details of accessories are subject to change without notice and availability may vary depending on the country of purchase.

Optional Accessories

Active 3D Glasses ELPGS03

Active shutter 3D Glasses (using Bluetooth communication). Use when viewing 3D images with this projector.

USB Charging Adapter ELPAC01

Use when charging the 3D Glasses.

Interactive Unit ELPIU01

Use when operating the computer screen on the projection surface.

Wireless LAN unit ELPAP07

Use this to project images from a computer via a wireless communication.

Quick Wireless Connection USB Key ELPAP09

Use when you want to quickly establish one-to-one connection between the projector and a computer with Windows installed.

Document Camera ELPDC06/ELPDC11/ELPDC12/ELPDC20

Use when projecting images such as books, OHP documents, or slides.

Soft carrying case ELPKS63

A soft case to carry the projector.

50" portable screen ELPSC32

A compact screen that can be carried easily. ([Aspect Ratio](#)▶▶ 4:3)

60" portable screen ELPSC27

80" portable screen ELPSC28

100" screen ELPSC29

Portable roll-type screens. (aspect ratio 4:3)

70" portable screen ELPSC23

80" portable screen ELPSC24

90" portable screen ELPSC25

Portable roll-type screens. (aspect ratio 16:10)

53" portable screen ELPSC30

64" portable screen ELPSC31

Portable magnetic screens. (aspect ratio 4:3)

Multi-aspect screen ELPSC26

This is a portable multi-aspect screen.

Computer cable ELPKC02

(1.8 m - for mini D-Sub15-pin/mini D-Sub 15pin)

Computer cable ELPKC09

(3 m - for mini D-Sub15-pin/mini D-Sub 15pin)

Computer cable ELPKC10

(20 m - for mini D-Sub15-pin/mini D-Sub 15pin)

Component video cable ELPKC19

(3 m - for mini D-Sub 15-pin/RCA male×3)

Use to connect a [component video](#)▶▶ source.

Ceiling pipe (450 mm)* ELPFP13

Ceiling pipe (700 mm)* ELPFP14

Use when installing the projector on a high ceiling.

Ceiling mount* ELPMB23

Use when installing the projector on a ceiling.

* Special expertise is required to suspend the projector from a ceiling. Contact your local dealer or the nearest address provided in the Epson Projector Contact List.

🔍 [Epson Projector Contact List](#)



Consumables

Lamp unit ELPLP78

Use as a replacement for used lamps.

Air filter ELPAF32

Use as a replacement for used air filters.

Projection Distance

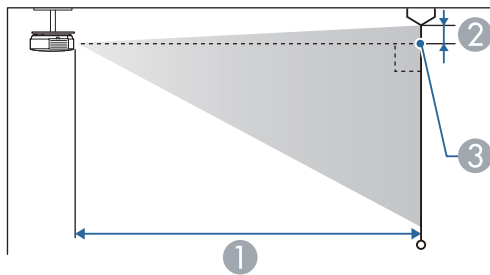
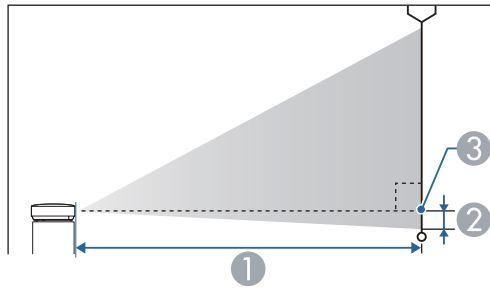

- ① Projection distance
- ② Distance from the center of the receiver's lens to the base of the screen (or to the top of the screen, if suspended from a ceiling)
- ③ Center of lens

Unit: cm

4:3 Screen Size		① Minimum (Wide) to Maximum (Tele)	②
30"	61x46	94 - 113	-4
40"	81x61	126 - 152	-5
50"	100x76	158 - 190	-7

4:3 Screen Size		① Minimum (Wide) to Maximum (Tele)	②
60"	120x91	190 - 229	-8
70"	142x107	222 - 267	-10
80"	160x120	255 - 306	-11
100"	200x150	319 - 383	-14
150"	300x230	480 - 577	-20
200"	410x300	641 - 770	-27
280"	570x430	898 - 1079	-38

Unit: cm

16:9 Screen Size		① Minimum (Wide) to Maximum (Tele)	②
35"	78x44	99 - 120	-2
40"	89x50	114 - 137	-2
50"	110x62	143 - 172	-3
60"	130x75	172 - 208	-3
70"	155x87	202 - 243	-4
80"	180x100	231 - 278	-4
100"	220x120	289 - 348	-5
150"	330x190	435 - 523	-8
200"	440x250	582 - 699	-11
310"	690x390	903 - 1084	-17

Unit: cm

16:10 Screen Size		①	②
		Minimum (Wide) to Maximum (Tele)	
35"	76x47	97 - 117	-4
40"	86x54	111 - 134	-5
50"	110x67	139 - 168	-6
60"	130x81	168 - 202	-7
80"	170x110	225 - 270	-10
100"	220x130	281 - 338	-12
150"	320x200	424 - 509	-18
200"	430x270	566 - 680	-24
320"	690x430	907 - 1089	-39

Supported Resolutions

Computer signals (analog RGB)

Signal	Refresh Rate (Hz)	Resolution (dots)
VGA	60/72/75/85	640x480
SVGA	56/60/72/75/85	800x600
XGA	60/70/75/85	1024x768
WXGA	60	1280x768
	60	1366x768
	60/75/85	1280x800
WXGA+	60/75/85	1440x900
WXGA++	60	1600x900
SXGA	70/75/85	1152x864
	60/75/85	1280x1024
	60/75/85	1280x960
SXGA+	60/75	1400x1050
WSXGA+*	60	1680x1050
UXGA	60	1600x1200
MAC13"	67	640x480
MAC16"	75	832x624
MAC19"	75	1024x768
	59	1024x768
MAC21"	75	1152x870

* Only compatible when **Wide** is selected as the **Resolution** from the Configuration menu.

Even when signals other than those mentioned above are input, it is likely that the image can be projected. However, not all functions may be supported.

Component video

Signal	Refresh Rate (Hz)	Resolution (dots)
SDTV (480i)	60	720x480
SDTV (576i)	50	720x576
SDTV (480p)	60	720x480
SDTV (576p)	50	720x576
HDTV (720p)	50/60	1280x720
HDTV (1080i)	50/60	1920x1080

Composite video

Signal	Refresh Rate (Hz)	Resolution (dots)
TV (NTSC)	60	720x480
TV (SECAM)	50	720x576
TV (PAL)	50/60	720x576

HDMI Input Signal

Signal	Refresh Rate (Hz)	Resolution (dots)
VGA	60	640x480
SVGA	60	800x600
XGA	60	1024x768
WXGA	60	1280x800
	60	1366x768

Signal	Refresh Rate (Hz)	Resolution (dots)
WXGA+	60	1440x900
WXGA++	60	1600x900
SXGA	60	1280x960
	60	1280x1024
SXGA+	60	1400x1050
UXGA	60	1600x1200
WSXGA+	60	1680x1050
SDTV (480i/480p)	60	720x480
SDTV (576i/576p)	50	720x576
HDTV (720p)	50/60	1280x720
HDTV (1080i)	50/60	1920x1080
HDTV (1080p)	24/30/50/60	1920x1080

MHL Input Signal

Signal	Refresh Rate (Hz)	Resolution (dots)
VGA	60	640x480
SDTV (480i/480p)	60	720x480
SDTV (576i/576p)	50	720x576
HDTV (720p)	50/60	1280x720
HDTV (1080i)	50/60	1920x1080
HDTV (1080p)	24/30	1920x1080

3D Input Signal (HDMI)

Signal	Refresh Rate (Hz)	Resolution (dots)	Frame Packing	Side by Side	Top and Bottom
HDTV750p (720p)	50/60	1280x720	✓	✓	✓
HDTV1125i (1080i)	50/60	1920x1080	-	✓	-
HDTV1125p (1080p)	50/60	1920x1080	-	✓	-
HDTV1125p (1080p)	24	1920x1080	✓	✓	✓

3D Input Signal (MHL)

Signal	Refresh Rate (Hz)	Resolution (dots)	Frame Packing	Side by Side	Top and Bottom
HDTV750p (720p)	50/60	1280x720	-	✓	✓
HDTV1125i (1080i)	50/60	1920x1080	-	✓	-
HDTV1125p (1080p)	50/60	1920x1080	-	-	-
HDTV1125p (1080p)	24	1920x1080	-	✓	✓

Projector General Specifications

Product name		EH-TW570	
Dimensions		297 (W) x 79 (H) x 234 (D) mm	
LCD panel size		0.59"	
Display method		Polysilicon TFT active matrix	
Resolution		1,024,000 WXGA (1280 (W) x 800 (H) dots) x 3	
Focus adjustment		Manual	
Zoom adjustment		Manually (1-1.2)	
Lamp		UHE lamp, 200 W Model No.: ELPLP78	
Max. audio output		2 W	
Speaker		1	
Power supply		100 - 240 V AC±10%, 50/60 Hz 2.9-1.3 A	
Power consumption	100 to 120 V area	Operating: 283 W Standby power consumption (Communication On): 2.9 W Standby power consumption (Communication Off): 0.24 W	
	220 to 240 V area	Operating: 270 W Standby power consumption (Communication On): 3.0 W Standby power consumption (Communication Off): 0.28 W	
Operating altitude		Altitude 0 to 3,000 m	
Operating temperature		+5 to +35°C (No condensation) (Altitude 0 to 2,286 m) +5 to +30°C (No condensation) (Altitude 2,287 to 3,000 m)	
Storage temperature		-10 to +60°C (No condensation)	
Mass		Approx. 2.4 kg	

Connectors	Computer port	1	Mini D-Sub15-pin (female)
	Video port	1	RCA pin jack

S-Video port	1	Mini DIN 4-pin
Audio port	1	RCA pin jack x 2
Audio Out port	1	Stereo mini jack (3.5Φ)
HDMI/MHL port	1	HDMI (Audio is only supported by PCM)
USB-A port*1	1	USB connector (Type A)
USB-B port*1, 2	1	USB connector (Type B)

*1 Supports USB 2.0. However, USB ports are not guaranteed to operate all devices that support USB.

*2 USB 1.1 is not supported.

This product is also designed for IT power distribution system with phase-to-phase voltage 230V.

Angle of tilt

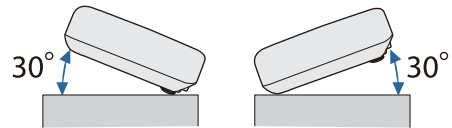

If you use the projector tilted at an angle of more than 30° it could be damaged and cause an accident.

DECLARATION of CONFORMITY

According to 47CFR, Part 2 and 15

Class B Personal Computers and Peripherals; and/or
CPU Boards and Power Supplies used with Class B Personal Computers

We: Epson America, Inc.
Located at: 3840 Kilroy Airport Way
MS: 3-13
Long Beach, CA 90806
Tel: 562-981-3840

Declare under sole responsibility that the product identified herein, complies with 47CFR Part 2 and 15 of the FCC rules as a Class B digital device. Each product marketed, is identical to the representative unit tested and found to be compliant with the standards. Records maintained continue to reflect the equipment being produced can be expected to be within the variation accepted, due to quantity production and testing on a statistical basis as required by 47CFR 2.909. Operation is subject to the following two conditions : (1) this device may not cause harmful interference, and (2) this device must accept any interference received, including interference that may cause undesired operation.

Trade Name: EPSON
Type of Product: LCD Projector
Model: H654C/H664C

**FCC Compliance Statement
For United States Users**

This equipment has been tested and found to comply with the limits for a Class B digital device, pursuant to Part 15 of the FCC Rules. These limits are designed to provide reasonable protection against harmful interference in a residential installation. This equipment generates, uses, and can radiate radio frequency energy and, if not installed and used in accordance with the instructions, may cause harmful interference to radio communications. However, there is no guarantee that interference will not occur in a particular installation. If this equipment does cause interference to radio and television reception, which can be determined by turning the equipment off and on, the user is encouraged to try to correct the interference by one or more of the following measures.

- Reorient or relocate the receiving antenna.
- Increase the separation between the equipment and receiver.
- Connect the equipment into an outlet on a circuit different from that to which the receiver is connected.
- Consult the dealer or an experienced radio/TV technician for help.

WARNING

The connection of a non-shielded equipment interface cable to this equipment will invalidate the FCC Certification or Declaration of this device and may cause interference levels which exceed the limits established by the FCC for this equipment. It is the responsibility of the user to obtain and use a shielded equipment interface cable with this device. If this equipment has more than one interface connector, do not leave cables connected to unused interfaces. Changes or modifications not expressly approved by the manufacturer could void the user's authority to operate the equipment.

Units: mm

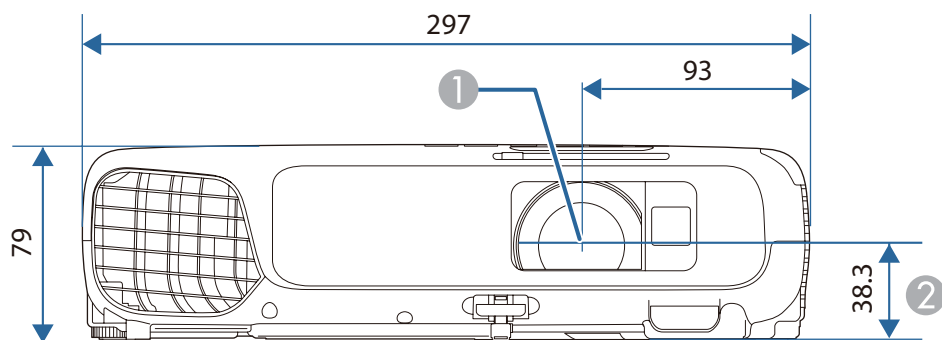

- ① Center of lens
- ② Distance from center of lens to suspension bracket fixing point

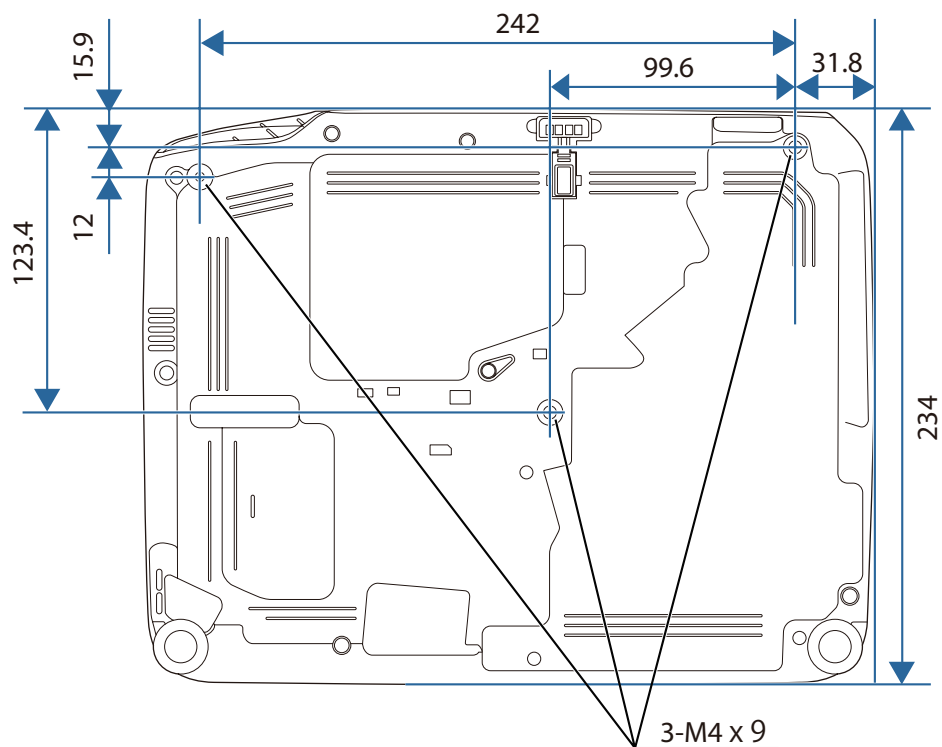

This section briefly explains the difficult terms that are not explained in the text of this guide. For details, refer to other commercially available publications.

Ad hoc mode	A method of wireless LAN connection that communicates with wireless LAN clients without using an access point.
Aspect Ratio	The ratio between an image's length and its height. Screens with a horizontal:vertical ratio of 16:9, such as HDTV screens, are known as wide screens. SDTV and general computer displays have an aspect ratio of 4:3.
Component Video	A method that separates the video signal into a luminance component (Y), and a blue minus luminance (Cb or Pb) and a red minus luminance (Cr or Pr).
Composite video	A method that combines the video signal into a luminance component and a color component for transmission down a single cable.
Contrast	The relative brightness of the light and dark areas of an image can be increased or decreased to make text and graphics stand out more clearly, or to make them appear softer. Adjusting this particular property of an image is called contrast adjustment.
DHCP	An abbreviation of Dynamic Host Configuration Protocol, this protocol automatically assigns an IP address to equipment connected to a network.
Gateway Address	This is a server (router) for communicating across a network (subnet) divided according to subnet mask .
HDCP	HDCP is an abbreviation for High-bandwidth Digital Content Protection. It is used to prevent illegal copying and protect copyrights by encrypting digital signals sent over DVI and HDMI ports. Because the HDMI/MHL port on this projector supports HDCP, it can project digital images protected by HDCP technology. However, the projector may not be able to project images protected with updated or revised versions of HDCP encryption.
HDTV	An abbreviation for High-Definition Television that refers to high-definition systems which satisfy the following conditions. <ul style="list-style-type: none"> • Vertical resolution of 720p or 1080i or greater (p = Progressive, i = Interlace) • Screen aspect ratio of 16:9
Infrastructure mode	A method for wireless LAN connection in which devices communicate through access points.
Interlace	Transmits information needed to create one screen by sending every other line, starting from the top of the image and working down to the bottom. Images are more likely to flicker because one frame is displayed every other line.
IP Address	A number to identify a computer connected to a network.
MHL	An abbreviation for Mobile High-definition Link, a standard for connection interfaces aimed at mobile devices such as smartphones and tablets. Images can be transferred at high quality and at high speeds without compressing the digital signal, and also charges connected devices.
Progressive	Projects information to create one screen at a time, displaying the image for one frame. Even though the number of scan lines is the same, the amount of flicker in images decreases because the volume of information has doubled compared with an interlace system.
Refresh Rate	The light-emitting element of a display maintains the same luminosity and color for an extremely short time. Because of this, the image must be scanned many times per second to refresh the light-emitting element. The number of refresh operations per second is called the Refresh Rate and is expressed in hertz (Hz).
SDTV	An abbreviation for Standard Definition Television that refers to standard television systems which do not satisfy the conditions for HDTV High-Definition Television.

SNMP	An abbreviation for Simple Network Management Protocol, which is the protocol for monitoring and controlling devices such as routers and computers connected to a TCP/IP network.
sRGB	An international standard for color intervals that was formulated so that colors that are reproduced by video equipment can be handled easily by computer operating systems (OS) and the Internet. If the connected source has an sRGB mode, set both the projector and the connected signal source to sRGB.
SSID	SSID is identification data for connecting to another device on a wireless LAN. Wireless communication is possible between devices with the same SSID.
Subnet Mask	This is a numerical value that defines the number of bits used for the network address on a divided network (subnet) from the IP address.
SVGA	A screen size standard with a resolution of 800 (horizontal) x 600 (vertical) dots.
S-Video	A method that separates the video signal into a luminance component (Y) and a color component (C).
SXGA	A screen size standard with a resolution of 1,280 (horizontal) x 1,024 (vertical) dots.
Sync.	The signals output from computers have a specific frequency. If the projector frequency does not match this frequency, the resulting images are not of a good quality. The process of matching the phases of these signals (the relative position of the crests and the troughs in the signal) is called Synchronization. If the signals are not synchronized, flickering, blurriness, and horizontal interference occur.
Tracking	The signals output from computers have a specific frequency. If the projector frequency does not match this frequency, the resulting images are not of a good quality. The process of matching the frequency of these signals (the number of crests in the signal) is called Tracking. If Tracking is not carried out correctly, wide vertical stripes appear in the signal.
Trap IP Address	This is the IP address for the destination computer used for error notification in SNMP.
VGA	A screen size standard with a resolution of 640 (horizontal) x 480 (vertical) dots.
XGA	A screen size standard with a resolution of 1,024 (horizontal) x 768 (vertical) dots.

All rights reserved. No part of this publication may be reproduced, stored in a retrieval system, or transmitted in any form or by any means, electronic, mechanical, photocopying, recording, or otherwise, without the prior written permission of Seiko Epson Corporation. No patent liability is assumed with respect to the use of the information contained herein. Neither is any liability assumed for damages resulting from the use of the information contained herein.

Neither Seiko Epson Corporation nor its affiliates shall be liable to the purchaser of this product or third parties for damages, losses, costs, or expenses incurred by the purchaser or third parties as a result of: accident, misuse, or abuse of this product or unauthorized modifications, repairs, or alterations to this product, or (excluding the U.S.) failure to strictly comply with Seiko Epson Corporation's operating and maintenance instructions.

Seiko Epson Corporation shall not be liable against any damages or problems arising from the use of any options or any consumable products other than those designated as Original Epson Products or Epson Approved Products by Seiko Epson Corporation.

The contents of this guide may be changed or updated without further notice.

Illustrations in this guide and the actual projector may differ.

Restriction of Use

When this product is used for applications requiring high reliability/safety such as transportation devices related to aviation, rail, marine, automotive etc.; disaster prevention devices; various safety devices etc; or functional/precision devices etc, you should use this product only after giving consideration to including fail-safes and redundancies into your design to maintain safety and total system reliability. Because this product was not intended for use in applications requiring extremely high reliability/safety such as aerospace equipment, main communication equipment, nuclear power control equipment, or medical equipment related to direct medical care etc, please make your own judgment on this product's suitability after a full evaluation.

About Notations

Microsoft® Windows® 2000 operating system
Microsoft® Windows® XP operating system
Microsoft® Windows® Vista operating system
Microsoft® Windows® 7 operating system
Microsoft® Windows® 8 operating system
Microsoft® Windows® 8.1 operating system

In this guide, the operating systems above are referred to as "Windows 2000", "Windows XP", "Windows Vista", "Windows 7", "Windows 8", and "Windows 8.1". Furthermore, the collective term Windows may be used to refer to Windows 2000, Windows XP, Windows Vista, Windows 7, Windows 8, and Windows 8.1, multiple versions of Windows may be referred to as, for example, Windows 2000/XP/Vista, with the Windows notation omitted.

Mac OS X 10.3.x
Mac OS X 10.4.x
Mac OS X 10.5.x
Mac OS X 10.6.x
OS X 10.7.x
OS X 10.8.x
OS X 10.9.x

In this guide, the operating systems above are referred to as "Mac OS X 10.3.9", "Mac OS X 10.4.x", "Mac OS X 10.5.x", "Mac OS X 10.6.x", "OS X 10.7.x", "OS X 10.8.x", and "OS X 10.9.x". Furthermore, the collective term "Mac OS" is used to refer to them.

General Notice:

EPSON and ELPLP are trademarks or registered trademarks of the SEIKO EPSON CORPORATION.

Mac, Mac OS, and OS X are trademarks of Apple Inc.

App Store is a service mark of Apple Inc.

Google play is a trademark of Google Inc.

Microsoft, Windows, Windows Vista, PowerPoint, and Windows logo are trademarks or registered trademarks of Microsoft Corporation in the United States and/or other countries.

WPA™ and WPA2™ are registered trademarks of Wi-Fi Alliance.

HDMI and High-Definition Multimedia Interface are the trademarks or registered trademarks of HDMI Licensing LLC. 

MHL, the MHL logo, and Mobile High-Definition Link are the trademarks or registered trademarks of MHL and LLC in the United States and/or other countries.

"QR Code" is a registered trademark of DENSO WAVE INCORPORATED.

Other product names used herein are also for identification purposes only and may be trademarks of their respective owners. Epson disclaims any and all rights in those marks.

©SEIKO EPSON CORPORATION 2014. All rights reserved.

A

A/V Mute	65
A/V Mute Timer	98
Air exhaust vent	11
Air filter replacement period	131
Aspect	44, 87
Auto Iris	44, 85
Auto Setup	86
Auto V-Keystone	88

B

Basic menu	92
Brightness	85

C

Ceiling	21, 89
Ceiling mount fixing points	13
Cinema	43
Cleaning	126
Cleaning the air filter and air intake vent	126
Cleaning the Projector's Surface	126
Color Adjustment	85
Color Mode	43, 85
Color Saturation	85
Color Temp.	85
Computer port	12
Configuration menu	82
Connection mode	93
Consumables	135
Continuous play	63
Contrast	85

Control panel	14
Control Panel Lock	73
Control panel lock	88
Cross	67

D

Direct Power On	90
Display	89
Display Background	89
Display order	62
Display settings	62
Document Camera	134
Dynamic	43

E

EasyMP Monitor	75
ECO Display	98
ECO menu	97
Email Address	96
ESC/VP21	78
Extended menu	89
E-Zoom	67

F

Focus ring	11
Foot adjust lever	11
Freeze	66
Front	21, 89
Front adjustable foot	11
Full Lock	73

G

Game	43
Gateway Address	94

H

HDMI port	12
HDMI Video Range	87
Help function	108
High Altitude Mode	90
H-Keystone adjuster	39
Horizontal keystone adjuster	8, 39
How to replace the air filter	131
How to replace the lamp	128

I

Image menu	85
Indicators	110
Info menu	98
Input Signal	87
IP Address	95

K

Keystone	88
----------------	----

L

Lamp cover	11
Lamp hours	97
Lamp indicator	110
Lamp replacement period	128
Language	90
Lens Cover Timer	98
Light Optimizer	97

- Living Room 43
- M**
- Mail Notification 77, 95
- Mail Notification menu 95
- Message Broadcasting 75
- Messages 89
- Monitor Displays 138
- Mouse pointer 68
- N**
- Network Configuration 91
- Network information 91
- Network Menu 90
- Network Protection 71
- Noise Reduction 87
- O**
- Operating temperature 140
- Operation 90
- Optional accessories 134
- Overheating 111
- P**
- Part Names and Functions 11
- Password protect 71
- PC Free 58, 61
- Pointer 66
- Pointer shape 88
- Port Number 95
- Position 86
- Power indicator 110
- Power inlet 12
- Power On Protect 71
- Presentation 57
- Problem Solving 110
- Progressive 86
- Projection 89
- Projection distance 136
- Projector keyword 92
- Projector Name 92
- Projector Setup 75
- Q**
- Quick Corner 88
- Quick Wireless Connection USB Key 134
- R**
- Reading Mail 77
- Rear 21, 89
- Rear feet 13
- Rear screen 21
- Remote control 15
- Remote receiver 11, 12
- Replacing batteries 18
- Reset all 99
- Reset menu 97, 99
- Resetting the lamp operating time
..... 99, 131
- Rotating images 60
- S**
- Screen size 136
- Screen switching time 63
- Security menu 94
- Select Drive 59
- Settings menu 88
- Sharpness 85
- Signal menu 85
- Sleep Mode 98
- Sleep Mode Timer 98
- SMTP Server 95
- SNMP 78
- Soft keyboard 91
- Source Search 14, 33
- Speaker 12
- Specifications 140
- SSID 93
- Standby Mode 98
- Startup Screen 89
- Storage temperature 140
- Subnet Mask 94
- Supported Monitor Displays 138
- S-Video port 12
- Sync. 86
- T**
- Temp indicator 110
- Test Pattern 88
- Tint 85
- Tracking 86
- U**
- USB Type B 90
- USB-A port 12
- USB-B port 12
- User button 88
- User's Logo 69

User's Logo Protection 71

V

Video port 12

Video signal 87

Volume 88

Volume buttons 14

W

Web Browser 75

Web Control 76

Web Control Password 92

Web Remote 76

Wireless LAN menu 93

Wireless LAN unit 134

Wireless mouse function 68

Z

Zoom ring 11